

Narzynki

Screwing dies
Schneideisen

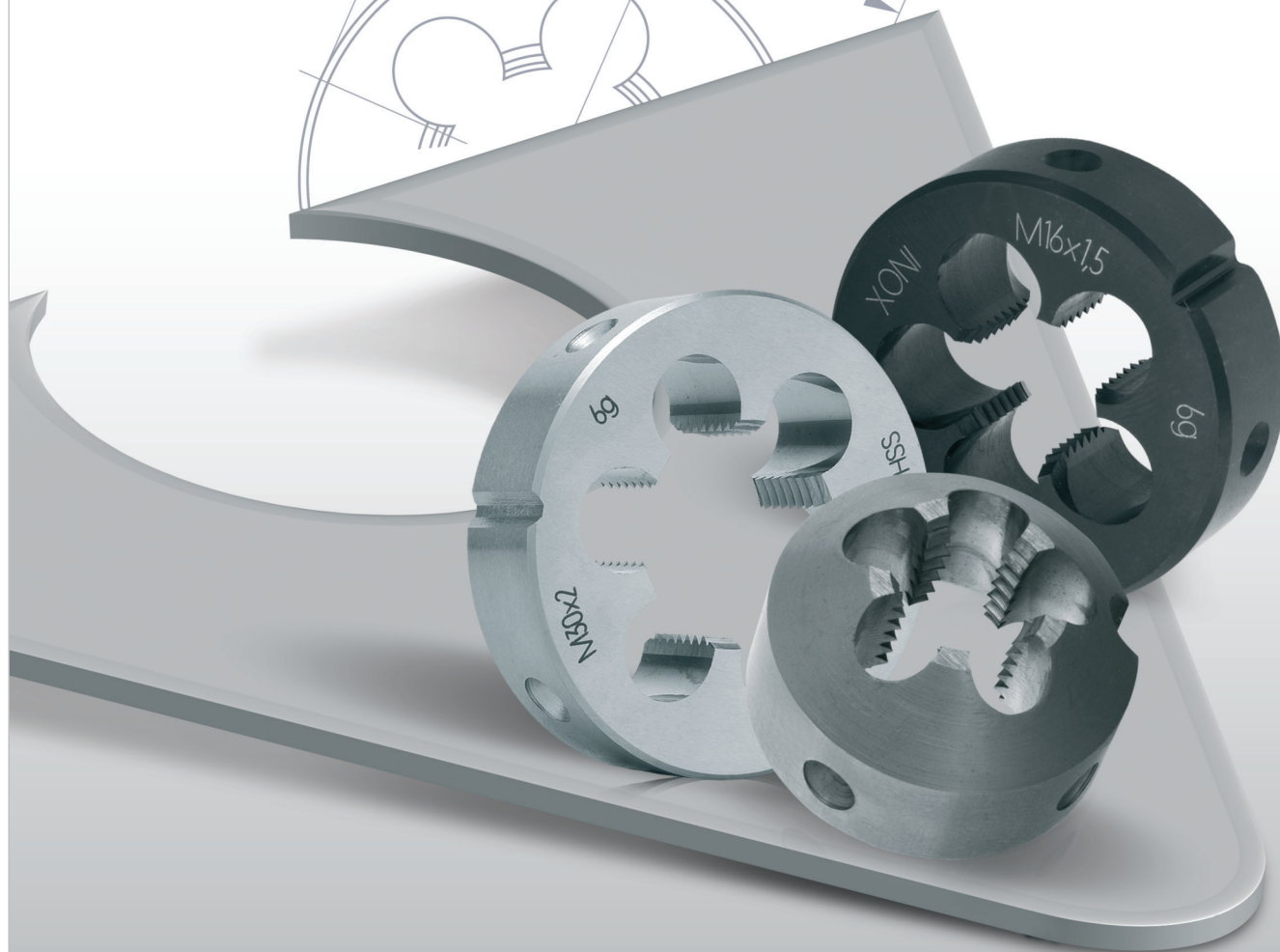
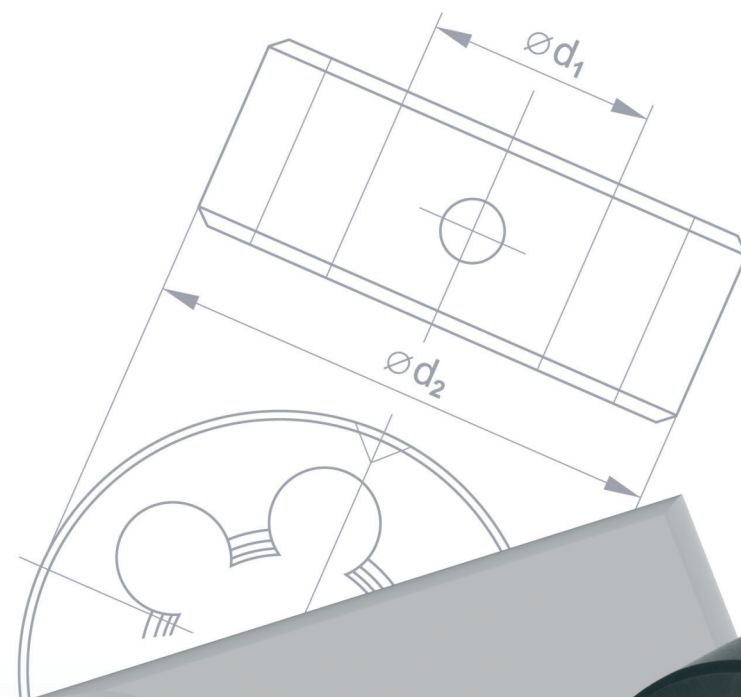

NARZYNKI
SCREWING DIES
SCHNEIDEISEN

Strona
Page
Seite

TABELA DOBORU NARZĘDZI / TOOLS SELECTION TABLE / WERKZEUGE SELEKTION TABELLE

141

STRONY KATALOGOWE / CATALOGUE PAGES / KATALOGSEITEN

142-148

M	DIN-EN 22 568	HSS, LH HSS, HSSE	800	800 SPN	INOX	Ms	142
	~DIN-EN 22 568	D-25, D-38 HSS	800				143
	NHMg	HSS	800		Ms	144	
MF	DIN-EN 22 568	HSS, HSSE	800	800 SPN	INOX	Ms	145-147
	~DIN-EN 22 568	D-25, D-38 HSS	800				148
	NHMg	HSS	800		Ms	149	
UNC	DIN-EN 22 568	HSS	800				150
UNF	DIN-EN 22 568	HSS	800				151
G	DIN-EN 24231	HSS, LH HSS, HSSE	800	INOX	Ms	152	
	DIN-EN 22 568	HSS	800		Ms	153	
R	DIN-EN 24 230	HSS	800				154
BSW	DIN-EN 22 568	HSS, LH HSS	800				155
BSF	DIN-EN 22 568	HSS	800				156
NPT	~DIN-EN 24 230	HSS	800				157
Pg	DIN-EN 22 568	HSS	800				158

TABELA DOBORU / SELECTION TABLE / SELEKTION TABELLE

						Norma Norm Norma	
DIN-EN 22 568, DIN-EN 24 231, DIN-EN 24 230				NHMg		M	Strona / Page / Seite
142-143	142	142	142	144	144	MF	
145-148	145-147	145-148	145-148	149	149	UNC	
150						UNF	
151						G	
152		152	152	153	153	R	
154						BSW	
155						BSF	
156						NPT	
157						Pg	
158						Nazwa Name Bezeichnung	
800	800 SPN	INOX	Ms	800	Ms	Wykonanie Execution Ausführung	
	SPN - skośna powierzchnia natarcia SPN - spiral point SPN - Schälanschnitt	SPN - skośna powierzchnia natarcia SPN - spiral point SPN - Schälanschnitt	Docierane; specjalna geometria Lapped; special geometry Geläppt; besondere Geometrie		Docierane; specjalna geometria Lapped; special geometry Geläppt; besondere Geometrie	Materiał Material Werkstoff	
HSS	HSS	HSSE	HSS	HSS	HSS	Rodzaj powłoki Coating Beschichtung	
		OX				Nakrój Chamfer Anschnitt	
1,75P	1,75P	2,25P	1,25P	1,75P	1,25P	Chłodziwo Coolant Kühlmittel	
E/O	E/O	E/O	E/O	E/O	E/O		
Vc [m/min]							
1-8							P
1-6							1.1
1-6							1.2
1-2							1.3
1-2							1.4
1-2							1.5
1-2							1.6
1-5							M
1-5							2.1
1-5							2.2
1-5							2.3
1-5							K
1-5							3.1
1-5							3.2
1-5							3.3
1-5							N
1-5							4.1
5-10							4.2
5-10							4.3
5-10							4.4
5-10							4.5
5-10							4.6
1-5							4.7
1-5							4.8
1-5							4.9
1-5							4.10
1-5							4.11
1-5							4.12
1-5							4.13
1-5							S
1-5							5.1
1-5							5.2
1-5							5.3
1-5							5.4
1-5							H
1-5							6.1
1-5							6.2
1-5							6.3
1-5							6.4

Gwint metryczny zwykły ISO DIN-13

ISO Metric coarse thread DIN-13

Metrisches ISO-Regelgewinde DIN-13

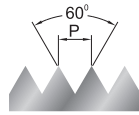

HSS HSSE

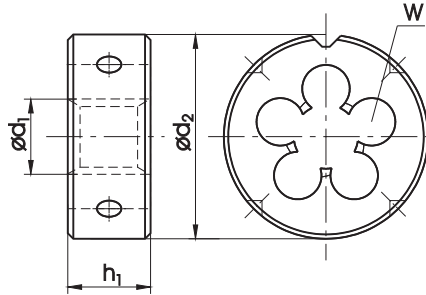

DIN-EN 22 568



LH

Nazwa / Name / Bezeichnung	800	800	800 SPN	INOX	Ms
Materiał obrabiany / Material / Werkstoff					
Rodzaj materiału / Quality of material / Qualität	HSS	HSS	HSS	HSSE	HSS
Wykonanie / Execution / Ausführung		LH			
Nakrój / Chamfer / Anschnitt	1,75P	1,75P	1,75P	2,25P	1,25P
Tolerancja / Tolerance / Toleranz	6g	6g	6g	6g	6g

M	P	$\varnothing d_2 \times h_1$	W		INDEX	N1-121001	N1-111001	N1-141001	N2-188001	N1-164001
M 1	0,25	16 x 5	3	0,96	0010	●				
M 1,1	0,25	16 x 5	3	1,05	0011	●				
M 1,2	0,25	16 x 5	3	1,15	0012	●				
M 1,4	0,3	16 x 5	3	1,35	0014	●				
M 1,6	0,35	16 x 5	3	1,55	0016	●				
M 1,8	0,35	16 x 5	3	1,75	0018	●				
M 2	0,4	16 x 5	3	1,95	0020	●				
M 2,2	0,45	16 x 5	3	2,15	0022	●				
M 2,5	0,45	16 x 5	3	2,42	0025	●				
M 3	0,5	20 x 5	3	2,92	0030	●	●		●	●
M 3,5	0,6	20 x 5	3	3,41	0035	●	●	●	●	●
M 4	0,7	20 x 5	3	3,90	0040	●	●	●	●	●
M 4,5	0,75	20 x 7	3	4,40	0045	●	●	●	●	●
M 5	0,8	20 x 7	3	4,90	0050	●	●	●	●	●
M 6	1	20 x 7	4	5,88	0060	●	●	●	●	●
M 7	1	25 x 9	4	6,88	0070	●	●	●	●	●
M 8	1,25	25 x 9	4	7,86	0080	●	●	●	●	●
M 9	1,25	25 x 9	4	8,86	0090	●	●	●	●	●
M 10	1,5	30 x 11	4	9,85	0100	●	●	●	●	●
M 11	1,5	30 x 11	4	10,85	0110	●	●	●	●	●
M 12	1,75	38 x 14	4	11,83	0120	●	●	●	●	●
M 14	2	38 x 14	4	13,82	0140	●	●	●	●	●
M 16	2	45 x 18	5	15,82	0160	●	●	●	●	●
M 18	2,5	45 x 18	5	17,79	0180	●	●	●	●	●
M 20	2,5	45 x 18	5	19,79	0200	●	●	●	●	●
M 22	2,5	55 x 22	5	21,79	0220	●	●	●	●	●
M 24	3	55 x 22	5	23,76	0240	●	●	●	●	●
M 27	3	65 x 25	5	26,76	0270	●	●	●	●	●
M 30	3,5	65 x 25	6	29,73	0300	●	●	●	●	●
M 33	3,5	65 x 25	6	32,73	0330	●	●	●	●	●
M 36	4	65 x 25	7	35,70	0360	●	●	●	●	●
M 39	4	75 x 30	7	38,70	0390	●	●	●	●	●
M 42	4,5	75 x 30	7	41,68	0420	●	●	●	●	●
M 45	4,5	90 x 36	7	44,68	0450	●	●	●	●	●
M 48	5	90 x 36	7	47,66	0480	●	●	●	●	●
M 52	5	90 x 36	8	51,66	0520	●	●	●	●	●
M 56	5,5	105 x 36	6	55,65	0560	○	○	○	○	○
M 60	5,5	105 x 36	8	59,65	0600	○	○	○	○	○
M 64	6	120 x 36	7	63,62	0640	○	○	○	○	○
M 68	6	120 x 36	8	67,62	0680	○	○	○	○	○

Przykład zamawiania / Example of order / Beispiel einer Bestellung:

N1-121001-0030
DIN-EN 22 568 M3 6g HSS 800

● Dostępne z magazynu, cena w cenniku

Available from stock, the price in the price list / Ab Lager lieferbar, der Preis in der Preisliste

○ Do szybkiej dostawy, cena na zapytanie

For quick delivery, price on request / Für die schnelle Lieferung, Preis auf Anfrage

Gwint metryczny zwykły ISO DIN-13

ISO Metric coarse thread DIN-13
 Metrisches ISO-Regelgewinde DIN-13

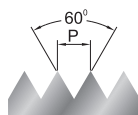

HSS

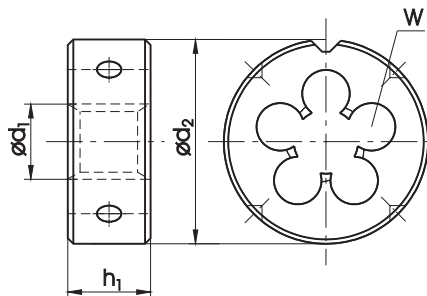

~DIN-EN 22 568



Nazwa / Name / Bezeichnung						800	800			
Materiał obrabiany / Material / Werkstoff										
Rodzaj materiału / Quality of material / Qualität						HSS	HSS			
Wykonanie / Execution / Ausführung						D25	D38			
Nakrój / Chamfer / Anschnitt						1,75P	1,75P			
Tolerancja / Tolerance / Toleranz						6g	6g			
M	P	$\varnothing d_2 \times h_1$	W		INDEX	N1-121251	N1-121381			
M 3	0,5	25 x 9	3	2,92	0030	●				
M 4	0,7	25 x 9	3	3,90	0040	●				
M 5	0,8	25 x 9	3	4,90	0050	●				
M 6	1	25 x 9	3	5,88	0060	●				
M 7*	1	25 x 9	4	6,88	0070*					
M 8*	1,25	25 x 9	4	7,86	0080*					
M 10	1,5	25 x 9	5	9,85	0100	●				
M 12	1,75	25 x 9	6	11,83	0120	●				
M 16	2	38 x 14	6	15,82	0160			●		
M 20	2,5	38 x 14	6	19,79	0200			●		

* Gabaryty standardowe dostępne pod indeksem N1-121001

* standard overall dimensions available with catalogue number N1-121001
 * Standardabmessungen sind unter dem Index N1-121001 erhältlich

Oprawki do narzynek na stronie 244

Die stocks at 244 page
 Schneideisenhalter auf der Seite 244



Przykład zamawiania / Example of order / Beispiel einer Bestellung:

N1-121251-0030
 DIN-EN 22 568 M3 6g HSS 800 D25

● Dostępne z magazynu, cena w cenniku

Available from stock, the price in the price list / Ab Lager lieferbar, der Preis in der Preisliste

○ Do szybkiej dostawy, cena na zapytanie

For quick delivery, price on request / Für die schnelle Lieferung, Preis auf Anfrage

Gwint metryczny zwykły ISO DIN-13

ISO Metric coarse thread DIN-13

Metrisches ISO-Regelgewinde DIN-13

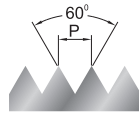

HSS

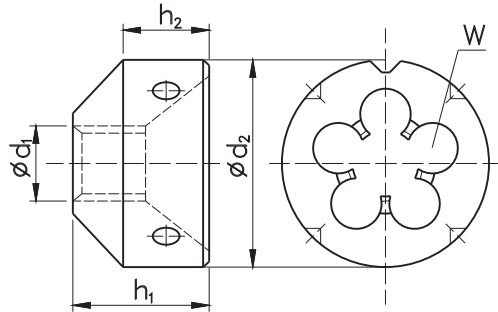

NHMg



Nazwa / Name / Bezeichnung

800

Ms

Materiał obrabiany / Material / Werkstoff

Rodzaj materiału / Quality of material / Qualität

HSS

HSS

Wykonanie / Execution / Ausführung

Nakrój / Chamfer / Anschnitt

1,75P

1,25P

Tolerancja / Tolerance / Toleranz

6g

6g

M	P	Ød ₂	h ₁	h ₂	W		INDEX	K1-821001	K1-864001
M 3	0,5	20	12	7	3	2,92	0030	○	○
M 4	0,7	20	12	7	3	3,90	0040	○	○
M 5	0,8	20	12	7	3	4,90	0050	○	○
M 6	1	20	12	7	4	5,88	0060	●	○
M 8	1,25	25	15	9	4	7,86	0080	●	○
M 10	1,5	25	15	9	5	9,85	0100	●	○
M 12	1,75	30	18	11	5	11,83	0120	●	○
M 14	2	30	18	11	5	13,82	0140	○	○
M 16	2	38	22	14	6	15,82	0160	○	○
M 18	2,5	38	22	14	6	17,79	0180	○	○
M 20	2,5	45	28	18	7	19,79	0200	○	○
M 22	2,5	45	28	18	6	21,79	0220	○	○
M 24	3	45	28	18	8	23,76	0240	○	○

Przykład zamawiania / Example of order / Beispiel einer Bestellung:

K1-821001-0030
NHMg M3 6g HSS 800

● Dostępne z magazynu, cena w cenniku

Available from stock, the price in the price list / Ab Lager lieferbar, der Preis in der Preisliste

○ Do szybkiej dostawy, cena na zapytanie

For quick delivery, price on request / Für die schnelle Lieferung, Preis auf Anfrage

Gwint metryczny drobnozwojny ISO DIN-13

ISO Metric fine thread DIN-13
Metrisches ISO-Feingewinde DIN-13

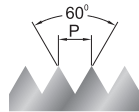

HSS HSSE

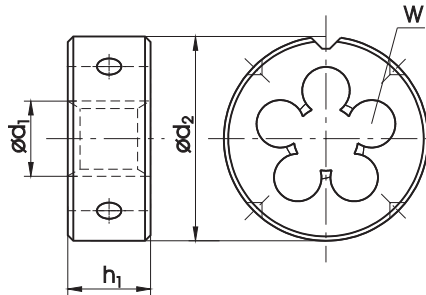

DIN-EN 22 568



Nazwa / Name / Bezeichnung	800	800	800 SPN	INOX	Ms
Materiał obrabiany / Material / Werkstoff					
Rodzaj materiału / Quality of material / Qualität	HSS	HSS	HSS	HSSE	HSS
Wykonanie / Execution / Ausführung		LH			
Nakrój / Chamfer / Anschnitt	1,75P	1,75P	1,75P	2,25P	1,25P
Tolerancja / Tolerance / Toleranz	6g	6g	6g	6g	6g

MF ϕd_1	P	$\phi d_2 \times h_1$	W		INDEX	N1-121001	N1-111001	N1-141001	N2-188001	N1-164001
M 3,5 x 0,5	0,5	20 x 5	3	3,43	0037	○	○	○	○	○
M 4 x 0,5	0,5	20 x 5	4	3,92	0041	●	○	○	○	○
M 4,5 x 0,5	0,5	20 x 5	4	4,43	0046	○	○	○	○	○
M 5 x 0,5	0,5	20 x 5	4	4,92	0051	○	○	○	○	○
M 5 x 0,75	0,75	20 x 5	4	4,91	0052	○	○	○	○	○
M 5,5 x 0,5	0,5	20 x 5	4	5,43	0056	○	○	○	○	○
M 5,5 x 0,75	0,75	20 x 7	4	5,42	0057	○	○	○	○	○
M 6 x 0,5	0,5	20 x 7	4	5,92	0061	●	○	○	○	○
M 6 x 0,75	0,75	20 x 7	4	5,90	0062	●	○	●	○	○
M 7 x 0,75	0,75	25 x 9	4	6,90	0072	●	○	●	○	○
M 8 x 0,5	0,5	25 x 9	4	7,92	0081	●	○	○	○	○
M 8 x 0,75	0,75	25 x 9	4	7,90	0082	●	●	●	○	●
M 8 x 1	1	25 x 9	4	7,88	0083	●	●	●	●	●
M 9 x 0,75	0,75	25 x 9	4	8,90	0092	●	○	○	○	○
M 9 x 1	1	25 x 9	4	8,88	0093	●	○	○	○	○
M 10 x 0,75	0,75	30 x 11	4	9,90	0102	●	○	●	○	○
M 10 x 1	1	30 x 11	5	9,88	0103	●	●	●	●	●
M 10 x 1,25	1,25	30 x 11	4	9,86	0104	●	●	●	○	○
M 11 x 0,75	0,75	30 x 11	5	10,91	0112	●	○	○	○	○
M 11 x 1	1	30 x 11	4	10,88	0113	●	○	●	○	○
M 12 x 1	1	38 x 10	5	11,88	0123	●	●	●	○	○
M 12 x 1,25	1,25	38 x 10	4	11,86	0124	●	●	●	○	○
M 12 x 1,5	1,5	38 x 10	4	11,85	0125	●	●	●	●	●
M 14 x 1	1	38 x 10	5	13,88	0143	●	●	○	○	○
M 14 x 1,5	1,5	38 x 10	5	13,85	0145	●	●	●	●	●
M 15 x 1	1	38 x 10	5	14,88	0153	●	○	○	○	○
M 15 x 1,5	1,5	38 x 10	5	14,85	0155	●	○	○	○	○
M 16 x 1	1	45 x 14	5	15,88	0163	●	●	○	○	○
M 16 x 1,5	1,5	45 x 14	5	15,85	0165	●	●	●	○	○
M 17 x 1	1	45 x 14	5	16,88	0173	●	○	○	○	○
M 17 x 1,5	1,5	45 x 14	5	16,85	0175	●	○	○	○	○
M 18 x 1	1	45 x 14	5	17,88	0183	●	○	○	○	○
M 18 x 1,5	1,5	45 x 14	5	17,85	0185	●	●	●	●	●
M 18 x 2	2	45 x 14	5	17,82	0186	●	●	○	○	○
M 20 x 1	1	45 x 14	6	19,80	0203	●	●	○	○	○
M 20 x 1,5	1,5	45 x 14	6	19,85	0205	●	●	●	○	○
M 20 x 2	2	45 x 14	6	19,82	0206	●	●	○	○	○
M 22 x 1	1	55 x 16	6	21,88	0223	●	●	○	○	○
M 22 x 1,5	1,5	55 x 16	6	21,85	0225	●	●	●	●	●
M 22 x 2	2	55 x 16	6	21,82	0226	●	●	○	○	○
M 24 x 1	1	55 x 16	6	21,88	0243	●	●	○	○	○
M 24 x 1,5	1,5	55 x 16	6	23,85	0245	●	●	●	●	●

Przykład zamawiania / Example of order / Beispiel einer Bestellung:

N1-121001-0103
DIN-EN 22 568 M10x1 6g HSS 800

● Dostępne z magazynu, cena w cenniku

Available from stock, the price in the price list / Ab Lager lieferbar, der Preis in der Preisliste

○ Do szybkiej dostawy, cena na zapytanie

For quick delivery, price on request / Für die schnelle Lieferung, Preis auf Anfrage

Gwint metryczny drobnozwojny ISO DIN-13

ISO Metric fine thread / DIN-13

Metrisches ISO-Feingewinde DIN-13

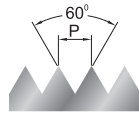

HSS HSSE

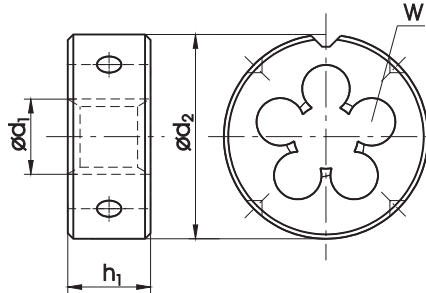

DIN-EN 22 568



Nazwa / Name / Bezeichnung	800	800	800 SPN	INOX	Ms
Materiał obrabiany / Material / Werkstoff					
Rodzaj materiału / Quality of material / Qualität	HSS	HSS	HSS	HSSE	HSS
Wykonanie / Execution / Ausführung		LH			
Nakrój / Chamfer / Anschnitt	1,75P	1,75P	1,75P	2,25P	1,25P
Tolerancja / Tolerance / Toleranz	6g	6g	6g	6g	6g

MF	P	$\varnothing d_2 \times h_1$	W		INDEX	N1-121001	N1-111001	N1-141001	N2-188001	N1-164001
M 24 x 2	2	55 x 16	6	23,82	0246	●	●	○	○	○
M 25 x 1	1	55 x 16	6	24,88	0253	●	○	○	○	○
M 25 x 1,5	1,5	55 x 16	6	24,85	0255	●	○	○	○	○
M 25 x 2	2	55 x 16	6	24,82	0256	●	○	○	○	○
M 26 x 1,5	1,5	55 x 16	6	25,85	0265	●	○	○	○	○
M 27 x 1	1	65 x 18	6	26,88	0273	●	○	○	○	○
M 27 x 1,5	1,5	65 x 18	6	26,85	0275	●	○	○	○	○
M 27 x 2	2	65 x 18	6	26,82	0276	●	○	○	○	○
M 28 x 1	1	65 x 18	6	27,88	0283	●	○	○	○	○
M 28 x 1,5	1,5	65 x 18	6	27,85	0285	●	○	○	○	○
M 28 x 2	2	65 x 18	6	27,82	0286	●	○	○	○	○
M 30 x 1	1	65 x 18	6	29,88	0303	●	○	○	○	○
M 30 x 1,5	1,5	65 x 18	6	29,85	0305	●	○	○	○	○
M 30 x 2	2	65 x 18	6	29,82	0306	●	○	○	○	○
M 30 x 3	3	65 x 18	6	29,76	0307	●	○	○	○	○
M 32 x 1,5	1,5	65 x 18	7	31,85	0325	●	○	○	○	○
M 32 x 2	2	65 x 18	7	31,82	0326	●	○	○	○	○
M 33 x 1,5	1,5	65 x 18	7	32,85	0335	●	○	○	○	○
M 33 x 2	2	65 x 18	7	32,82	0336	●	○	○	○	○
M 33 x 3	3	65 x 18	7	32,76	0337	●	○	○	○	○
M 35 x 1,5	1,5	65 x 18	7	34,85	0355	●	○	○	○	○
M 36 x 1,5	1,5	65 x 18	7	35,85	0365	●	○	○	○	○
M 36 x 2	2	65 x 18	7	35,82	0366	●	○	○	○	○
M 36 x 3	3	65 x 25	7	35,76	0367	●	○	○	○	○
M 38 x 1,5	1,5	75 x 20	7	37,85	0385	●	○	○	○	○
M 39 x 1,5	1,5	75 x 20	7	38,85	0395	●	○	○	○	○
M 39 x 2	2	75 x 20	7	38,82	0396	●	○	○	○	○
M 39 x 3	3	75 x 30	7	38,76	0397	●	○	○	○	○
M 40 x 1,5	1,5	75 x 20	7	39,85	0405	●	○	○	○	○
M 40 x 2	2	75 x 20	7	39,82	0406	●	○	○	○	○
M 40 x 3	3	75 x 30	7	39,76	0407	●	○	○	○	○
M 42 x 1,5	1,5	75 x 20	8	41,85	0425	●	○	○	○	○
M 42 x 2	2	75 x 20	8	41,82	0426	●	○	○	○	○
M 42 x 3	3	75 x 30	7	41,76	0427	●	○	○	○	○
M 45 x 1,5	1,5	90 x 22	7	44,85	0455	●	○	○	○	○
M 45 x 2	2	90 x 22	7	44,82	0456	●	○	○	○	○
M 45 x 3	3	90 x 36	7	44,76	0457	●	○	○	○	○
M 48 x 1,5	1,5	90 x 22	7	47,85	0485	●	○	○	○	○
M 48 x 2	2	90 x 22	7	47,82	0486	●	○	○	○	○
M 48 x 3	3	90 x 36	7	47,76	0487	●	○	○	○	○
M 48 x 4	4	90 x 36	7	47,73	0488	●	○	○	○	○
M 50 x 1,5	1,5	90 x 22	8	49,85	0505	●	○	○	○	○

Przykład zamawiania / Example of order / Beispiel einer Bestellung:

N1-121001-0306

DIN-EN 22 568 M30x2 6g HSS 800

● Dostępne z magazynu, cena w cenniku

Available from stock, the price in the price list / Ab Lager lieferbar, der Preis in der Preisliste

○ Do szybkiej dostawy, cena na zapytanie

For quick delivery, price on request / Für die schnelle Lieferung, Preis auf Anfrage

Gwint metryczny drobnozwojny ISO DIN-13

ISO Metric fine thread DIN-13

Metrisches ISO-Feingewinde DIN-13

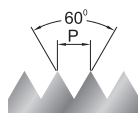

HSS HSSE

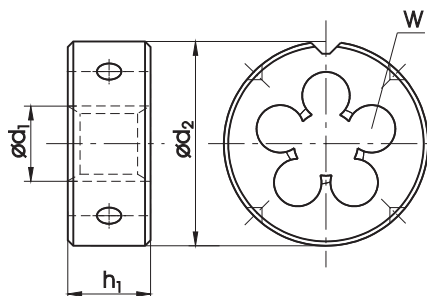
DIN-EN 22 568

Nazwa / Name / Bezeichnung						800	800	800 SPN	INOX	Ms
Materiał obrabiany / Material / Werkstoff										
Rodzaj materiału / Quality of material / Qualität						HSS	HSS	HSS	HSSE	HSS
Wykonanie / Execution / Ausführung							LH			
Nakrój / Chamfer / Anschnitt						1,75P	1,75P	1,75P	2,25P	1,25P
Tolerancja / Tolerance / Toleranz						6g	6g	6g	6g	6g
MF ϕd_1	P	$\phi d_2 \times h_1$	W		INDEX	N1-121001	N1-111001	N1-141001	N2-188001	N1-164001
M 50 x 2	2	90 x 22	8	49,82	0506	●	○	○	○	○
M 50 x 3	3	90 x 36	8	49,76	0507	●	○	○	○	○
M 52 x 1,5	1,5	90 x 36	8	51,85	0525	●	○	○	○	○
M 52 x 2	2	90 x 22	8	51,82	0526	●	○	○	○	○
M 52 x 3	3	90 x 36	8	51,76	0527	●	○	○	○	○
M 52 x 4	4	90 x 36	8	51,73	0528	●	○	○	○	○
M 55 x 1,5	1,5	105 x 22	8	54,85	0555	○	○	○	○	○
M 55 x 2	2	105 x 22	7	54,82	0556	○	○	○	○	○
M 55 x 3	3	105 x 36	7	54,76	0557	○	○	○	○	○
M 55 x 4	4	105 x 36	7	54,73	0558	○	○	○	○	○
M 56 x 1,5	1,5	105 x 22	8	55,85	0565	○	○	○	○	○
M 56 x 2	2	105 x 22	8	55,82	0566	○	○	○	○	○
M 56 x 3	3	105 x 36	8	55,76	0567	○	○	○	○	○
M 56 x 4	4	105 x 36	7	55,73	0568	○	○	○	○	○

Przykład zamawiania / Example of order / Beispiel einer Bestellung:

 N1-121001-0506
 DIN-EN 22 568 M50x2 6g HSS 800

● Dostępne z magazynu, cena w cenniku

Available from stock, the price in the price list / Ab Lager lieferbar, der Preis in der Preisliste

○ Do szybszej dostawy, cena na zapytanie

For quick delivery, price on request / Für die schnelle Lieferung, Preis auf Anfrage

Gwint metryczny drobnozwojny ISO DIN-13

ISO Metric fine thread DIN-13

Metrisches ISO-Feingewinde DIN-13

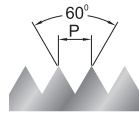

HSS

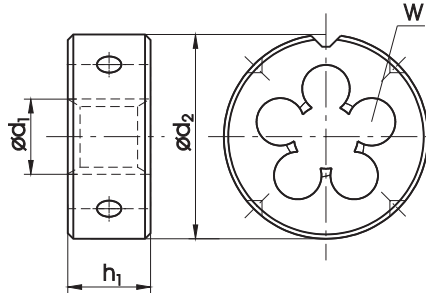

~DIN-EN 22 568



Nazwa / Name / Bezeichnung						800	800			
Materiał obrabiany / Material / Werkstoff										
Rodzaj materiału / Quality of material / Qualität						HSS	HSS			
Wykonanie / Execution / Ausführung						D25	D38			
Nakrój / Chamfer / Anschnitt						1,75P	1,75P			
Tolerancja / Tolerance / Toleranz						6g	6g			
MF $\varnothing d_1$	P	$\varnothing d_2 \times h_1$	W		INDEX	N1-121251	N1-121381			
M 8 x 1*	1	25 x 9	4	7,88	0083*					
M 10 x 1	1	25 x 9	5	9,88	0103	●				
M 10 x 1,25	1,25	25 x 9	5	9,86	0104	●				
M 12 x 1,25	1,25	25 x 9	6	11,86	0124	●				
M 12 x 1,5	1,5	25 x 9	6	11,85	0125	●				
M 16 x 1,5	1,5	38 x 14	6	15,85	0165		●			
M 18 x 1,5	1,5	38 x 14	6	17,85	0185		●			

* Gabaryty standardowe dostępne pod indeksem N1-121001

* standard overall dimensions available with catalogue number N1-121001
 * Standardabmessungen sind unter dem Index N1-121001 erhältlich

Przykład zamawiania / Example of order / Beispiel einer Bestellung:

N1-121251-0103

DIN-EN 22 568 M10x1 6g HSS 800 D25

● Dostępne z magazynu, cena w cenniku

Available from stock, the price in the price list / Ab Lager lieferbar, der Preis in der Preisliste

○ Do szybkiej dostawy, cena na zapytanie

For quick delivery, price on request / Für die schnelle Lieferung, Preis auf Anfrage

Gwint metryczny drobnozwojny ISO DIN-13

ISO Metric fine thread DIN-13

Metrisches ISO-Feingewinde DIN-13

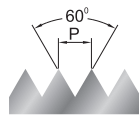

HSS

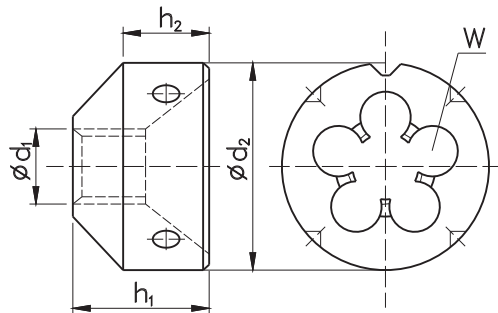
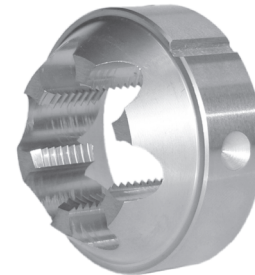
NHMg

Nazwa / Name / Bezeichnung								800	Ms		
Materiał obrabiany / Material / Werkstoff											
Rodzaj materiału / Quality of material / Qualität								HSS	HSS		
Wykonanie / Execution / Ausführung											
Nakrój / Chamfer / Anschnitt								1,75P	1,25P		
Tolerancja / Tolerance / Toleranz								6g	6g		
MF Ød ₁	P	Ød ₂	h ₁	h ₂	W		INDEX	K1-821001	K1-864001		
M 8 x 1	1	25	15	9	4	7,88	0083	o	o		
M 10 x 1	1	25	15	9	5	9,88	0103	o	o		
M 12 x 1	1	30	18	11	6	11,88	0123	o	o		
M 14 x 1	1	30	18	11	6	13,88	0143	o	o		
M 14 x 1,5	1,5	30	18	11	6	13,85	0145	o	o		
M 16 x 1,5	1,5	38	22	14	6	15,85	0165	o	o		
M 18 x 1,5	1,5	38	22	14	6	17,85	0185	o	o		
M 20 x 1,5	1,5	38	22	14	7	19,85	0205	o	o		
M 22 x 1,5	1,5	45	28	18	6	21,85	0225	o	o		
M 24 x 1,5	1,5	45	28	18	8	23,85	0245	o	o		

3

Przykład zamawiania / Example of order / Beispiel einer Bestellung:

 K1-821001-0103
 NHMg M10x1 6g HSS 800

● Dostępne z magazynu, cena w cenniku

Available from stock, the price in the price list / Ab Lager lieferbar, der Preis in der Preisliste

○ Do szybkiej dostawy, cena na zapytanie

For quick delivery, price on request / Für die schnelle Lieferung, Preis auf Anfrage

Gwint amerykański zunifikowany UNC, ANSI B-1.1

American unified coarse thread UNC, ANSI B-1.1

Amerikanisches Unified - Grobgewinde UNC, ANSI B-1.1

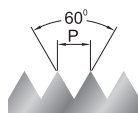

HSS

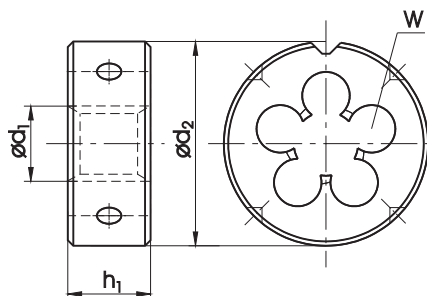

DIN-EN 22 568



Nazwa / Name / Bezeichnung

800

800

Materiał obrabiany / Material / Werkstoff

Rodzaj materiału / Quality of material / Qualität

HSS

HSS

Wykonanie / Execution / Ausführung

LH

Nakrój / Chamfer / Anschnitt

1,75P

1,75P

Tolerancja / Tolerance / Toleranz

2A

2A

UNC	$\varnothing d_1$	1"/P	P	$\varnothing d_2 \times h_1$	W		INDEX	N1-121001	N1-111001
No 5 - 40	3,175	40	0,635	20 x 5	3	3,09	4105	●	○
No 6 - 32	3,505	32	0,794	20 x 5	3	3,41	4106	●	○
No 8 - 32	4,166	32	0,794	20 x 7	3	4,07	4108	●	○
No 10 - 24	4,826	24	1,058	20 x 7	3	4,71	4110	●	○
No 12 - 24	5,486	24	1,058	20 x 7	4	5,37	4112	●	○
1/4 - 20	6,350	20	1,270	20 x 7	4	6,22	4127	●	○
5/16 - 18	7,938	18	1,411	25 x 9	4	7,80	4128	●	○
3/8 - 16	9,525	16	1,588	30 x 11	4	9,37	4129	●	○
7/16 - 14	11,112	14	1,814	30 x 11	4	10,95	4130	●	○
1/2 - 13	12,700	13	1,954	38 x 14	4	12,52	4131	●	○
9/16 - 12	14,288	12	2,117	38 x 14	4	14,10	4132	●	○
5/8 - 11	15,875	11	2,309	45 x 18	5	15,68	4133	●	○
3/4 - 10	19,050	10	2,504	45 x 18	5	18,84	4135	●	○
7/8 - 9	22,225	9	2,822	55 x 22	5	22,00	4137	●	○
1 - 8	25,400	8	3,175	55 x 22	5	25,16	4139	●	○
1.1/8 - 7	28,575	7	3,629	65 x 25	5	28,31	4141	○	○
1.1/4 - 7	31,750	7	3,629	65 x 25	6	31,49	4143	○	○
1.3/8 - 6	34,925	6	4,233	65 x 25	7	34,63	4145	○	○
1.1/2 - 6	38,100	6	4,233	75 x 30	6	37,80	4147	○	○
1.3/4 - 5	44,450	5	5,080	90 x 36	6	44,12	4151	○	○
2 - 4.1/2	50,800	4.1/2	5,645	90 x 36	7	50,45	4155	○	○

Przykład zamawiania / Example of order / Beispiel einer Bestellung:

N1-121001-4127

DIN-EN 22 568 1/4-20 UNC 2A HSS 800

● Dostępne z magazynu, cena w cenniku

Available from stock, the price in the price list / Ab Lager lieferbar, der Preis in der Preisliste

○ Do szybkiej dostawy, cena na zapytanie

For quick delivery, price on request / Für die schnelle Lieferung, Preis auf Anfrage

**Gwint amerykański zunifikowany
drobnozwojny UNF, ANSI B-1.1**

American unified fine thread UNF, ANSI B-1.1
Amerikanisches Unified - Feingewinde UNF, ANSI B-1.1

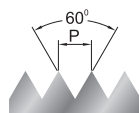

HSS

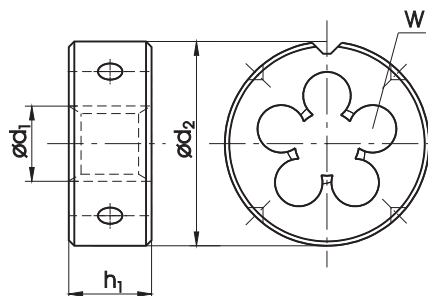

DIN-EN 22 568



Nazwa / Name / Bezeichnung							800	800				
Materiał obrabiany / Material / Werkstoff												
Rodzaj materiału / Quality of material / Qualität							HSS	HSS				
Wykonanie / Execution / Ausführung								LH				
Nakrój / Chamfer / Anschnitt							1,75P	1,75P				
Tolerancja / Tolerance / Toleranz							2A	2A				
UNF	$\varnothing d_1$	1"/P	P	$\varnothing d_2 \times h_1$	W		INDEX	N1-121001	N1-111001			
No 5 - 44	3,175	44	0,577	20 x 5	3	3,10	4205	●	○			
No 6 - 40	3,505	40	0,635	20 x 5	3	3,42	4206	●	○			
No 8 - 36	4,166	36	0,705	20 x 7	3	4,08	4208	●	○			
No 10 - 32	4,826	32	0,794	20 x 7	3	4,73	4210	●	○			
No 12 - 28	5,486	28	0,907	20 x 7	4	5,38	4212	●	○			
1/4 - 28	6,350	28	0,907	20 x 7	4	6,24	4227	●	○			
5/16 - 24	7,938	24	1,058	25 x 9	5	7,82	4228	●	○			
3/8 - 24	9,525	24	1,058	30 x 11	4	9,41	4229	●	○			
7/16 - 20	11,112	20	1,270	30 x 11	5	10,98	4230	●	○			
1/2 - 20	12,700	20	1,270	38 x 10	5	12,56	4231	●	○			
9/16 - 18	14,288	18	1,411	38 x 10	5	14,14	4232	●	○			
5/8 - 18	15,875	18	1,411	45 x 14	5	15,73	4233	●	○			
3/4 - 16	19,050	16	1,588	45 x 14	6	18,89	4235	●	○			
7/8 - 14	22,225	14	1,814	55 x 16	5	22,05	4237	●	○			
1 - 12	25,400	12	2,117	55 x 16	6	25,21	4239	●	○			
1.1/8 - 12	28,575	12	2,117	65 x 18	6	28,38	4241	○	○			
1.1/4 - 12	31,750	12	2,117	65 x 18	6	31,55	4243	○	○			
1.3/8 - 12	34,925	12	2,117	65 x 18	7	34,73	4245	○	○			
1.1/2 - 12	38,100	12	2,117	75 x 20	8	37,90	4247	○	○			

3

Przykład zamawiania / Example of order / Beispiel einer Bestellung:
N1-121001-4239
DIN-EN 22 568 1-12 UNF 2A HSS 800

- Dostępne z magazynu, cena w cenniku
Available from stock, the price in the price list / Ab Lager lieferbar, der Preis in der Preisliste
- Do szybkiej dostawy, cena na zapytanie
For quick delivery, price on request / Für die schnelle Lieferung, Preis auf Anfrage

Gwint rurowy walcowy G, DIN-ISO 228

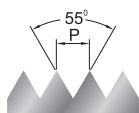
Whitworth pipe thread G, DIN-ISO 228
Whitworth Rohrgewinde G, DIN-ISO 228

HSS HSSE

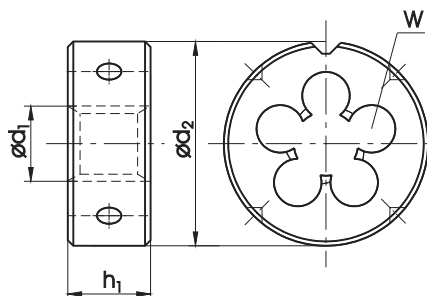

DIN-EN 24 231



Nazwa / Name / Bezeichnung							800	800	INOX	Ms
Materiał obrabiany / Material / Werkstoff										
Rodzaj materiału / Quality of material / Qualität							HSS	HSS	HSSE	HSS
Wykonanie / Execution / Ausführung								LH		
Nakrój / Chamfer / Anschnitt							1,75P	1,75P	2,25P	1,25P
Tolerancja / Tolerance / Toleranz							A	A	A	A
G	$\varnothing d_1$	1"/P	P	$\varnothing d_2 \times h_1$	W	INDEX	N1-121001	N1-111001	N2-188001	N1-164001
G-1/8"	9,73	28	0,907	30 x 11	4	9,62 3123	●	○	●	●
G-1/4"	13,16	19	1,337	38 x 10	4	13,03 3127	●	●	●	●
G-3/8"	16,66	19	1,337	45 x 14	5	16,54 3129	●	●	●	●
G-1/2"	20,96	14	1,814	45 x 14	6	20,81 3131	●	●	●	●
G-5/8"	22,91	14	1,814	55 x 16	5	22,77 3133	●	○	○	○
G-3/4"	26,44	14	1,814	55 x 16	6	26,30 3135	●	●	●	●
G-7/8"	30,20	14	1,814	65 x 18	6	30,06 3137	●	○	○	○
G-1"	33,25	11	2,309	65 x 18	7	33,07 3139	●	●	●	●
G-1.1/8"	37,90	11	2,309	75 x 20	7	37,72 3141	○	○	○	○
G-1.1/4"	41,91	11	2,309	75 x 20	8	41,73 3143	●	○	○	○
G-1.3/8"	44,32	11	2,309	90 x 22	7	44,14 3145	○	○	○	○
G-1.1/2"	47,80	11	2,309	90 x 22	7	47,62 3147	●	○	○	○
G-1.3/4"	53,75	11	2,309	105 x 22	8	53,57 3151	○	○	○	○
G-2"	59,61	11	2,309	105 x 22	8	59,43 3155	○	○	○	○
G-2.1/4"	65,71	11	2,309	120 x 22	8	65,49 3157	○	○	○	○

Gwint rurowy walcowy G, DIN-ISO 228

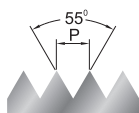
 Whitworth pipe thread G, DIN-ISO 228
 Whitworth Rohrgewinde G, DIN-ISO 228

HSS

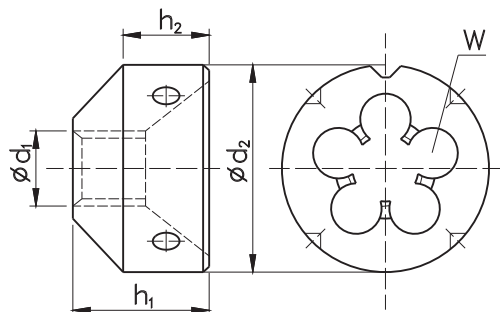
NHMg

Nazwa / Name / Bezeichnung

800

Ms

Materiał obrabiany / Material / Werkstoff
Rodzaj materiału / Quality of material / Qualität

HSS

HSS

Wykonanie / Execution / Ausführung
Nakrój / Chamfer / Anschnitt

1,75P

1,25P

Tolerancja / Tolerance / Toleranz

A

A

G	ϕd_1	1"/P	P	ϕd_2	h_1	h_2	W		INDEX	K1-821001	K1-864001
G-1/8"	9,73	28	0,907	30	18	11	5	9,62	3123	o	●
G-1/4"	13,16	19	1,337	38	18	10	5	13,03	3127	o	●
G-3/8"	16,66	19	1,337	45	18	10	5	16,54	3129	o	●
G-1/2"	20,96	14	1,814	45	23	14	6	20,81	3131	o	●
G-5/8"	22,91	14	1,814	55	27	16	5	22,77	3133	o	o
G-3/4"	26,44	14	1,814	55	27	16	6	26,30	3135	o	●

3

Przykład zamawiania / Example of order / Beispiel einer Bestellung:

 K1-864001-3131
 NHMg G-1/2" A HSS Ms

● Dostępne z magazynu, cena w cenniku

Available from stock, the price in the price list / Ab Lager lieferbar, der Preis in der Preisliste

○ Do szybkiej dostawy, cena na zapytanie

For quick delivery, price on request / Für die schnelle Lieferung, Preis auf Anfrage

Gwint rurowy stożkowy R, ISO-7/1

Whitworth pipe external thread R, ISO-7/1

Kegelliges Whitworth-Rohr-Außengewinde R, ISO-7/1

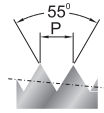

HSS

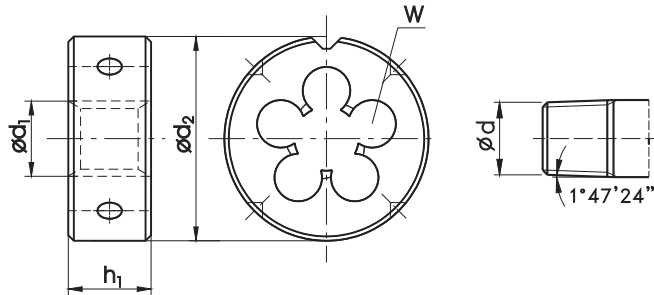
**DIN-EN 24 230**

Nazwa / Name / Bezeichnung

800

Materiał obrabiany / Material / Werkstoff

Rodzaj materiału / Quality of material / Qualität

HSS

Wykonanie / Execution / Ausführung

Nakrój / Chamfer / Anschnitt

2P

Tolerancja / Tolerance / Toleranz

R	$\varnothing d_1$	1"/P	P	$\varnothing d_2 \times h_1$	W		INDEX	N1-121001			
R-1/8"	9,73	28	0,907	30 x 11	5	9,48	3423	●			
R-1/4"	13,16	19	1,337	38 x 14	5	12,78	3427	●			
R-3/8"	16,16	19	1,337	45 x 18	5	16,26	3429	●			
R-1/2"	20,96	14	1,814	55 x 22	5	20,44	3431	●			
R-3/4"	26,44	14	1,814	55 x 22	6	25,85	3435	●			
R-1"	32,25	11	2,309	65 x 25	7	32,60	3439	●			

Przykład zamawiania / Example of order / Beispiel einer Bestellung:

N1-121001-3427
DIN-EN 24 230 R-1/4" HSS 800

● Dostępne z magazynu, cena w cenniku

Available from stock, the price in the price list / Ab Lager lieferbar, der Preis in der Preisliste

○ Do szybkiej dostawy, cena na zapytanie

For quick delivery, price on request / Für die schnelle Lieferung, Preis auf Anfrage

Gwint calowy zwykły Whitwortha BSW, BS-84:1956

Whitworth thread BSW, BS-84:1956
Whitworth-Gewinde BSW, BS-84:1956

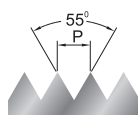

HSS

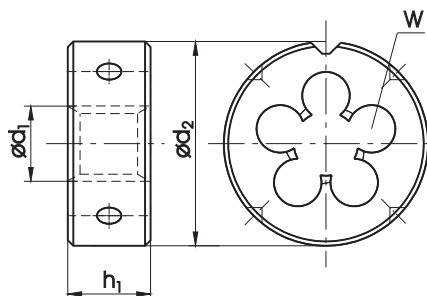

DIN-EN 22 568



Nazwa / Name / Bezeichnung							800	800				
Materiał obrabiany / Material / Werkstoff												
Rodzaj materiału / Quality of material / Qualität							HSS	HSS				
Wykonanie / Execution / Ausführung								LH				
Nakrój / Chamfer / Anschnitt							1,75P	1,75P				
Tolerancja / Tolerance / Toleranz							medium class	medium class				
BSW	$\varnothing d_1$	1"/P	P	$\varnothing d_2 \times h_1$	W		INDEX	N1-121001	N1-111001			
1/8 - 40	3,18	40	0,635	20 x 5	3	3,09	7123	●	○			
3/16 - 24	4,76	24	1,058	20 x 7	4	4,66	7125	●	○			
1/4 - 20	6,35	20	1,270	20 x 7	4	6,24	7127	●	○			
5/16 - 18	7,94	18	1,411	25 x 9	4	7,82	7128	●	○			
3/8 - 16	9,53	16	1,588	30 x 11	4	9,40	7129	●	○			
7/16 - 14	11,11	14	1,814	30 x 11	4	10,98	7130	●	○			
1/2 - 12	12,70	12	2,117	38 x 14	4	12,56	7131	●	○			
9/16 - 12	14,29	12	2,117	38 x 14	4	14,14	7132	●	○			
5/8 - 11	15,88	11	2,309	45 x 18	5	15,72	7133	●	○			
3/4 - 10	19,05	10	2,504	45 x 18	5	18,89	7135	●	○			
7/8 - 9	22,23	9	2,822	55 x 22	5	22,10	7137	●	○			
1 - 8	25,40	8	3,175	55 x 22	5	25,27	7139	●	○			

3

Przykład zamawiania / Example of order / Beispiel einer Bestellung:

N1-121001-7123
DIN-EN 22 568 1/8-40 BSW HSS 800

- Dostępne z magazynu, cena w cenniku
Available from stock, the price in the price list / Ab Lager lieferbar, der Preis in der Preisliste
- Do szybkiej dostawy, cena na zapytanie
For quick delivery, price on request / Für die schnelle Lieferung, Preis auf Anfrage

**Gwint calowy drobnozwojny Whitwortha
BSF, BS-84:1956**

British Whitworth fine thread BSF, BS-84:1956
Britisches Whitworth - Feingewinde BSF, BS-84:1956

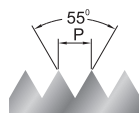

HSS

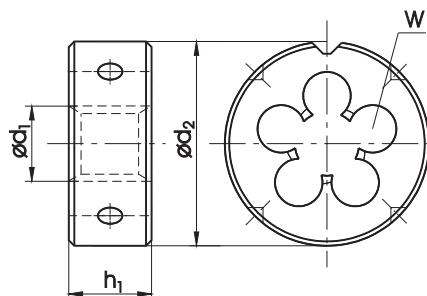

DIN-EN 22 568



Nazwa / Name / Bezeichnung							800	800				
Materiał obrabiany / Material / Werkstoff												
Rodzaj materiału / Quality of material / Qualität							HSS	HSS				
Wykonanie / Execution / Ausführung								LH				
Nakrój / Chamfer / Anschnitt							1,75P	1,75P				
Tolerancja / Tolerance / Toleranz							medium class	medium class				
BSF	$\varnothing d_1$	1"/P	P	$\varnothing d_2 \times h_1$	W		INDEX	N1-121001	N1-111001			
3/16 - 32	4,76	32	0,794	20 x 7	4	4,76	7225	●	○			
1/4 - 26	6,35	26	0,977	20 x 7	4	6,25	7227	●	○			
5/16 - 22	7,94	22	1,155	25 x 9	4	7,83	7228	●	○			
3/8 - 20	9,53	20	1,270	30 x 11	4	9,41	7229	●	○			
7/16 - 18	11,11	18	1,411	30 x 11	5	10,99	7230	●	○			
1/2 - 16	12,70	16	1,588	38 x 10	5	12,57	7231	●	○			
9/16 - 16	14,29	16	1,588	38 x 10	4	14,16	7232	●	○			
5/8 - 14	15,88	14	1,814	45 x 14	4	15,73	7233	●	○			
3/4 - 12	19,05	12	2,117	45 x 14	5	18,89	7235	●	○			
7/8 - 11	22,23	11	2,309	55 x 22	5	22,11	7237	●	○			
1 - 10	25,40	10	2,504	55 x 22	5	25,28	7239	●	○			

Gwint amerykański rurowy stożkowy
NPT 1:16, ANSI B-1.20.1

American tapered pipe thread
NPT 1:16, ANSI B-1.20.1
Amerikanisches kegeliges Rohrgewinde
NPT 1:16, ANSI B-1.20.1

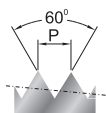

HSS

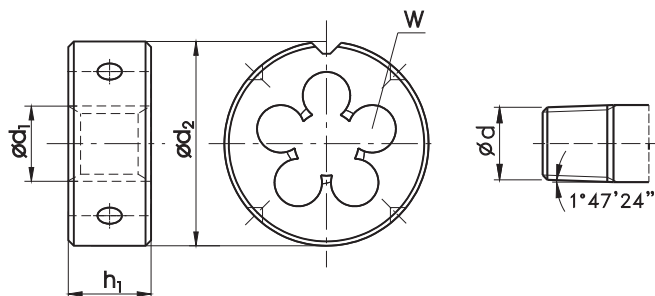

DIN-EN 24 230



Nazwa / Name / Bezeichnung

800

Materiał obrabiany / Material / Werkstoff

Rodzaj materiału / Quality of material / Qualität

HSS

Wykonanie / Execution / Ausführung

Nakrój / Chamfer / Anschnitt

2P

Tolerancja / Tolerance / Toleranz

NPT	$\varnothing d_1$	1"/P	P	$\varnothing d_2 \times h_1$	W		INDEX	N1-121001				
1/8"	9,728	27	0,941	30 x 11	5	9,99	4623	●				
1/4"	13,157	18	1,411	38 x 14	5	13,26	4627	●				
3/8"	16,662	18	1,411	45 x 18	5	16,67	4629	●				
1/2"	20,955	14	1,814	45 x 18	6	20,71	4631	●				
3/4"	26,441	14	1,814	55 x 22	6	26,03	4635	●				
1"	33,249	11.1/2	2,209	65 x 25	7	32,59	4639	●				

3

Przykład zamawiania / Example of order / Beispiel einer Bestellung:

N1-121001-4627
DIN-EN 24 230 1/4" NPT HSS 800

● Dostępne z magazynu, cena w cenniku

Available from stock, the price in the price list / Ab Lager lieferbar, der Preis in der Preisliste

○ Do szybkiej dostawy, cena na zapytanie

For quick delivery, price on request / Für die schnelle Lieferung, Preis auf Anfrage

**Gwint do rurek instalacyjnych
stalowych Pg, DIN-40430**

Steel conduit thread Pg, DIN-40430

Stahlpanzerrohr - Gewinde Pg, DIN-40430

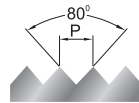

HSS

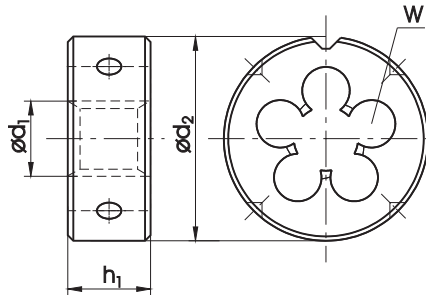

DIN-EN 22 568



Nazwa / Name / Bezeichnung

800

Materiał obrabiany / Material / Werkstoff

Rodzaj materiału / Quality of material / Qualität

HSS

Wykonanie / Execution / Ausführung

Nakrój / Chamfer / Anschnitt

1,75P

Tolerancja / Tolerance / Toleranz

Pg	$\varnothing d_1$	1"/P	P	$\varnothing d_2 \times h_1$	W		INDEX	N1-121001				
Pg 7	12,5	20	1,270	38 x 10	4	12,40	8807	●				
Pg 9	15,2	18	1,411	45 x 14	5	15,10	8809	●				
Pg 11	18,6	18	1,411	45 x 14	5	18,50	8811	●				
Pg 13,5	20,4	18	1,411	45 x 14	5	20,30	8813	●				
Pg 16	22,5	18	1,411	55 x 16	5	22,40	8816	●				
Pg 21	28,3	16	1,588	65 x 18	6	28,15	8821	●				
Pg 29	37,0	16	1,588	65 x 18	7	36,85	8829	●				
Pg 36	47,0	16	1,588	90 x 22	7	46,85	8836	○				
Pg 42	54,0	16	1,588	105 x 22	9	53,85	8842	○				
Pg 48	59,3	16	1,588	105 x 22	8	59,15	8848	○				

Gwint Pg jest zastępowany gwintem metrycznym drobnozwojnym MF wg normy DIN EN 60423 dostępnym na zapytanie

Pg thread is replaced by metric fine MF according to DIN EN 60423 available on request

Pg-Gewinde wird durch metrisches Feingewinde ersetzt nach Norm DIN EN 60423 auf Anfrage



Przykład zamawiania / Example of order / Beispiel einer Bestellung:

N1-121001-8807
DIN-EN 22 568 Pg7 HSS 800

● Dostępne z magazynu, cena w cenniku

Available from stock, the price in the price list / Ab Lager lieferbar, der Preis in der Preisliste

○ Do szybkiej dostawy, cena na zapytanie

For quick delivery, price on request / Für die schnelle Lieferung, Preis auf Anfrage