

































Frezy trzpieniowe
Opti Line



katalog
2014
Opti Line

SPIS TREŚCI

Strona

FREZY TRZPIENIOWE 2-ostrzowe	 	230	VHM	2
FREZY TRZPIENIOWE 3-ostrzowe	 	345	VHM	3
FREZY TRZPIENIOWE 4-ostrzowe	 	430	VHM	4
FREZY TRZPIENIOWE 2-ostrzowe kuliste	 	B230	VHM	5
FREZY TRZPIENIOWE 4-ostrzowe kuliste	 	B430	VHM	6
FREZY TRZPIENIOWE 2-ostrzowe długie	 	230L	VHM	7
FREZY TRZPIENIOWE 4-ostrzowe długie	 	430L	VHM	8
FREZY TRZPIENIOWE 2-ostrzowe do rowków na wpusty	Typ N  	DIN-327	HSSE HSSE-PM	9
FREZY TRZPIENIOWE 2-ostrzowe długie	Typ N  	DIN-327	HSSE	10
FREZY TRZPIENIOWE 2-ostrzowe kuliste	 	DIN-1889	HSSE	11
FREZY TRZPIENIOWE 4-ostrzowe krótkie	Typ N  	DIN-844	HSSE HSSE-PM	12
FREZY TRZPIENIOWE 4-ostrzowe długie	Typ N  	DIN-844	HSSE	13
FREZY TRZPIENIOWE Z ŁAMACZEM WIÓRÓW 4-ostrzowe krótkie, typ NR	Typ NR  	DIN-844	HSSE	14
FREZY TRZPIENIOWE 4-ostrzowe krótkie z chwytem morese'a	Typ HR  	DIN-845	HSSE PM	15
FREZY TRZPIENIOWE 1-ostrzowe, typ W	Typ W  	DIN-844 DIN-844	HSSE	16
FREZY TRZPIENIOWE 4-ostrzowe krótkie z chwytem morese'a 4-ostrzowe długie z chwytem morese'a	Typ N  	DIN-845 DIN-845	HSSE	17
INFORMACJE TECHNICZNE				18÷20

OZNACZENIA

- - Dostępne z magazynu, cena w cenniku
- - Do szybkiej dostawy, cena na zapytanie



Z=2

$\lambda=35^\circ$

VHM

UNI

230

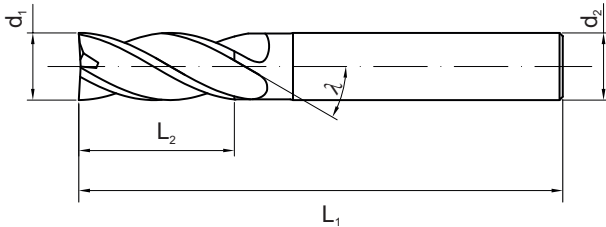

czołowo-walcowe



TiAlN

d_1	d_2	L_1	L_2	Z	INDEX M9-220418	
Wersja MICRO						
1	4	50	3	2	0010	o
1.5	4	50	4	2	0015	o
2.0	4	50	6	2	0020	•
2.5	4	50	8	2	0025	•
3	4	50	8	2	0030	•
Wersja STANDARD						
4	4	50	11	2	0040	•
5	6	50	13	2	0050	•
6	6	50	16	2	0060	•
8	8	60	20	2	0080	•
10	10	75	25	2	0100	•
12	12	75	30	2	0120	•
14	14	100	35	2	0140	•
16	16	100	40	2	0160	•
18	18	100	45	2	0180	•
20	20	100	45	2	0200	•

MATERIAŁ	Stale Konstrukcyjne Węgłowe Stale Stopowe		Stale Stopowe, Stale Narzędziowe		Stale Hartowane	
	-HRC30		-HRC50		-HRC60	
ŚREDNICA	PRĘDKOŚĆ OBR (obr/min)	POSUW (mm/min)	PRĘDKOŚĆ OBR (obr/min)	POSUW (mm/min)	PRĘDKOŚĆ OBR (obr/min)	POSUW (mm/min)
1	20000	80	15000	45	11000	30
1,5	13600	135	10000	60	9000	40
2	9600	150	8500	50	6000	45
3	6500	200	5800	75	4000	60
4	5500	250	4000	80	3200	60
5	4500	300	3000	80	2500	70
6	4000	300	2500	80	2200	70
8	3500	350	2200	90	1700	70
10	3000	400	2000	90	1500	70
12	2500	400	1500	100	1000	70
16	2000	400	1200	100	800	70

GŁĘBOKOŚĆ SKRAWANIA

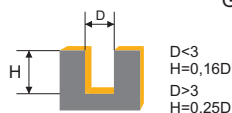

TWARDOŚĆ < 45 HRC

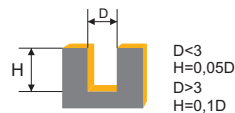

TWARDOŚĆ > 45 HRC



345

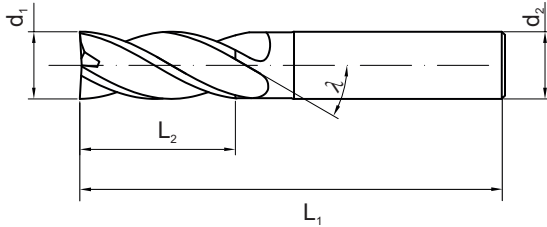

czołowo-walcowe



TiAlN

d ₁	d ₂	L ₁	L ₂	Z	INDEX M9-140418	
Wersja STANDARD						
3	4	50	8	3	0030	•
4	5	50	11	3	0040	•
5	6	50	13	3	0050	•
6	6	50	16	3	0060	•
7	8	58	20	3	0070	•
8	8	58	20	3	0080	•
9	10	72	25	3	0090	•
10	10	72	25	3	0100	•
11	12	73	30	3	0110	•
12	12	73	30	3	0120	•
14	14	83	35	3	0140	•
16	16	92	40	3	0160	•
18	18	100	45	3	0180	•
20	20	99	45	3	0200	•

MATERIAŁ	Stale Konstrukcyjne Węgłowe Stale Stopowe		Stale Stopowe, Stale Narzędziowe		Stale Hartowane	
	-HRC30		-HRC50		-HRC60	
TWARDOŚĆ						
ŚREDNICA	PRĘDKOŚĆ OBR (obr/min)	POSUW (mm/min)	PRĘDKOŚĆ OBR (obr/min)	POSUW (mm/min)	PRĘDKOŚĆ OBR (obr/min)	POSUW (mm/min)
3	8000	550	5500	300	3500	200
4	6500	550	4500	300	2200	200
5	5000	800	3600	350	1800	210
6	4000	800	2800	350	1500	210
8	3500	800	2600	350	1300	210
10	2500	800	2000	350	1100	210
12	1800	750	1500	350	700	210
16	1400	700	1000	300	500	170

GŁĘBOKOŚĆ SKRAWANIA

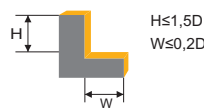

TWARDOŚĆ < 45 HRC

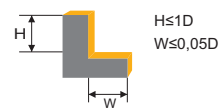

TWARDOŚĆ > 45 HRC



430

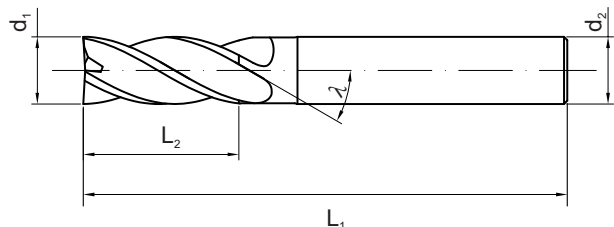

czołowo-walcowe



d ₁	d ₂	L ₁	L ₂	Z	INDEX M9-120518	
Wersja MICRO						
1	4	50	3	4	0010	o
1.5	4	50	4	4	0015	o
2.0	4	50	6	4	0020	•
2.5	4	50	8	4	0025	•
3	4	50	8	4	0030	•
Wersja STANDARD						
4	4	50	11	4	0040	•
5	6	50	13	4	0050	•
6	6	50	16	4	0060	•
8	8	60	20	4	0080	•
10	10	75	25	4	0100	•
12	12	75	30	4	0120	•
14	14	100	35	4	0140	•
16	16	100	40	4	0160	•
18	18	100	45	4	0180	•
20	20	100	45	4	0200	•

MATERIAŁ	Stale Konstrukcyjne Węglowe Stale Stopowe		Stale Stopowe, Stale Narzędziowe		Stale Hartowane	
	-HRC30		-HRC50		-HRC60	
TWARDOŚĆ						
ŚREDNICA	PRĘDKOŚĆ OBR (obr/min)	POSUW (mm/min)	PRĘDKOŚĆ OBR (obr/min)	POSUW (mm/min)	PRĘDKOŚĆ OBR (obr/min)	POSUW (mm/min)
1	22000	400	18000	200	9000	140
1,5	12000	500	11000	280	5200	150
2	10000	550	10000	280	4600	170
3	9000	600	5500	310	3500	220
4	6000	600	5000	400	2200	220
5	4800	750	4000	400	1700	240
6	4500	800	3800	420	1600	300
8	3500	820	2800	420	1000	300
10	3000	820	1800	420	900	300
12	2000	820	1600	350	800	300
16	1500	650	1000	300	500	150
20	1200	650	900	300	400	150

GŁĘBOKOŚĆ SKRAWANIA



TWARDOŚĆ < 45 HRC



TWARDOŚĆ > 45 HRC



B230

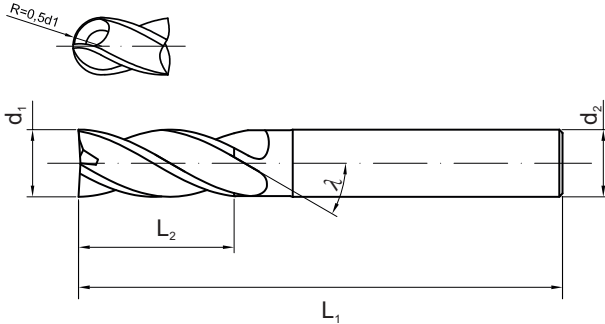

kuliste



d ₁	d ₂	L ₁	L ₂	Z	INDEX M9-510418	
Wersja MICRO						
1	4	50	2	2	0010	○
1,5	4	50	3	2	0015	○
2	4	50	4	2	0020	○
2,5	4	50	5	2	0025	○
3	4	50	6	2	0030	○
Wersja STANDARD						
4	4	50	8	2	0040	●
5	6	50	10	2	0050	●
6	6	50	12	2	0060	●
8	8	60	16	2	0080	●
10	10	75	20	2	0100	●
12	12	75	24	2	0120	●
16	16	100	32	2	0160	●
20	20	100	40	2	0200	●

MATERIAŁ	Stale Konstrukcyjne Węglove Stale Stopowe		Stale Stopowe, Stale Narzędziowe		Stale Hartowane	
	-HRC30		-HRC50		-HRC60	
TWARDOŚĆ						
PROMIĘŃ	PRĘDKOŚĆ OBR (obr/min)	POSUW (mm/min)	PRĘDKOŚĆ OBR (obr/min)	POSUW (mm/min)	PRĘDKOŚĆ OBR (obr/min)	POSUW (mm/min)
0,5	45000	800	35000	600	20000	200
1	23000	800	18000	600	10000	200
1,5	16000	1000	12000	600	6500	200
2	12000	1000	9500	700	5000	300
3	8000	1100	6000	700	3500	300
4	6000	1200	5000	800	2500	350
5	5000	1100	4000	800	2000	350
6	4000	1000	3000	700	1500	300
8	3000	1000	2000	700	1000	300

GLĘBOKOŚĆ SKRAWANIA

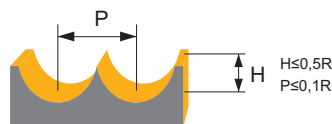

TWARDOŚĆ < 45 HRC

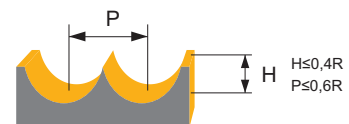

TWARDOŚĆ > 45 HRC



B430

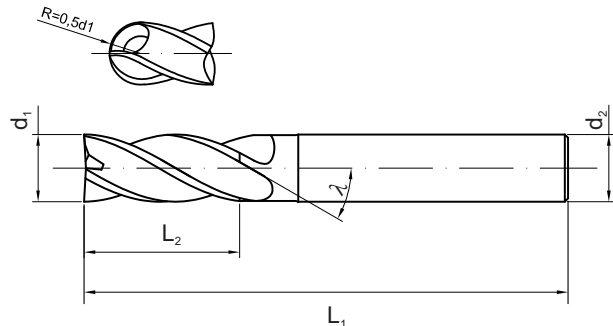

kuliste



TiAlN

d ₁	d ₂	L ₁	L ₂	Z	INDEX M9-530718	
Wersja MICRO						
1	4	50	2	4	0010	○
1,5	4	50	3	4	0015	○
2	4	50	4	4	0020	○
2,5	4	50	5	4	0025	○
3	4	50	6	4	0030	○
Wersja STANDARD						
4	4	50	8	4	0040	●
5	6	50	10	4	0050	●
6	6	50	12	4	0060	●
8	8	60	16	4	0080	●
10	10	75	20	4	0100	●
12	12	75	24	4	0120	●

MATERIAŁ	Stale Konstrukcyjne Węgłowe Stale Stopowe		Stale Stopowe, Stale Narzędziowe		Stale Hartowane	
	-HRC30		-HRC50		-HRC60	
TWARDOŚĆ						
PROMIĘŃ	PRĘDKOŚĆ OBR (obr/min)	POSUW (mm/min)	PRĘDKOŚĆ OBR (obr/min)	POSUW (mm/min)	PRĘDKOŚĆ OBR (obr/min)	POSUW (mm/min)
2	12000	1200	9500	900	5000	400
3	8000	1400	6000	900	3500	500
4	6000	1600	5000	1000	2500	600
5	5000	1400	4000	1000	2000	600
6	4000	1200	3000	900	1500	500
8	3000	1200	2500	900	1000	500
10	2500	1000	2000	600	900	300

GŁĘBOKOŚĆ SKRAWANIA

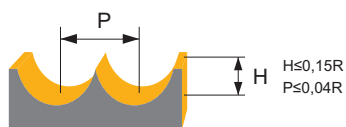

TWARDOŚĆ < 45 HRC

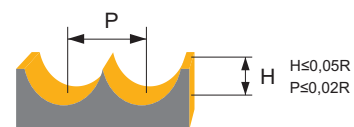

TWARDOŚĆ > 45 HRC



230L

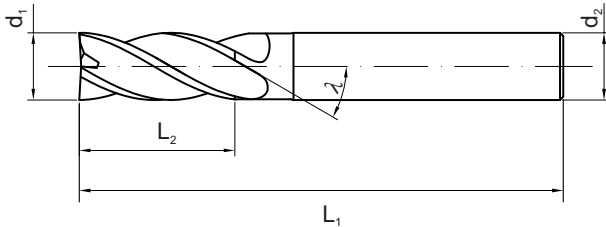

czołowo-walcowe



TiAlN

d ₁	d ₂	L ₁	L ₂	Z	INDEX M9-121418	
Wersja MICRO						
6	6	75	15	2	0060	o
6	6	100	15	2	0060A	o
8	8	100	20	2	0080	o
10	10	100	25	2	0100	o
10	10	150	25	2	0100A	o
Wersja STANDARD						
12	12	100	30	2	0120	o
12	12	150	30	2	0120A	o

MATERIAŁ	Stale Konstrukcyjne Węglowe Stale Stopowe		Stale Stopowe, Stale Narzędziowe		Stale Hartowane	
	-HRC30		-HRC50		-HRC60	
ŚREDNICA	PRĘDKOŚĆ OBR (obr/min)	POSUW (mm/min)	PRĘDKOŚĆ OBR (obr/min)	POSUW (mm/min)	PRĘDKOŚĆ OBR (obr/min)	POSUW (mm/min)
6	4000	300	2500	80	2200	70
8	3500	350	2200	90	1700	70
10	3000	400	2000	90	1500	70
12	2500	400	1500	100	1000	70
16	2000	400	1200	100	800	70

GŁĘBOKOŚĆ SKRAWANIA

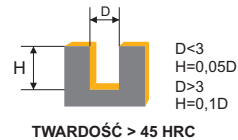
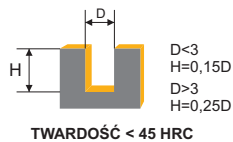



430L

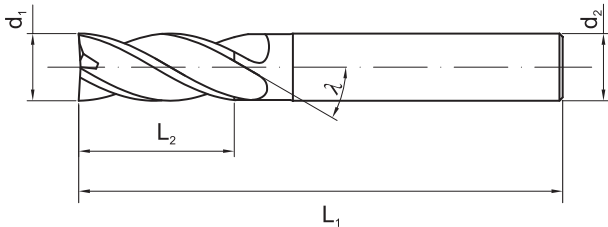

czołowo-walcowe



TiAlN

d ₁	d ₂	L ₁	L ₂	Z	INDEX M9-121518	
Wersja MICRO						
2	4	50	15	4	0020	○
3	4	50	20	4	0030	○
4	4	75	25	4	0040	○
5	6	75	30	4	0050	○
6	6	75	30	4	0060	○
Wersja STANDARD						
8	8	100	40	4	0080	●
10	10	100	40	4	0100	●
12	12	100	45	4	0120	●
16	16	150	60	4	0160	●
20	20	150	60	4	0200	●

MATERIAŁ	Stale Konstrukcyjne Węgłowe Stale Stopowe		Stale Stopowe, Stale Narzędziowe		Stale Hartowane	
	-HRC30		-HRC50		-HRC60	
TWARDOŚĆ	PRĘDKOŚĆ OBR (obr/min)	POSUW (mm/min)	PRĘDKOŚĆ OBR (obr/min)	POSUW (mm/min)	PRĘDKOŚĆ OBR (obr/min)	POSUW (mm/min)
ŚREDNICA						
2	3000	50	2500	40	1000	15
3	2500	60	2000	50	800	20
4	2000	80	1700	70	700	30
5	1800	110	1500	85	60	40
6	1500	110	1400	75	550	50
8	1300	110	1100	75	450	50
10	1000	110	800	75	300	50
12	900	110	700	75	250	40
16	800	95	500	70	150	20
20	500	80	400	80	120	20

GŁĘBOKOŚĆ SKRAWANIA

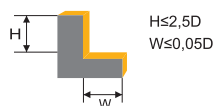

TWARDOŚĆ < 45 HRC

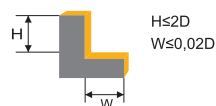

TWARDOŚĆ > 45 HRC



DIN-327

UNI

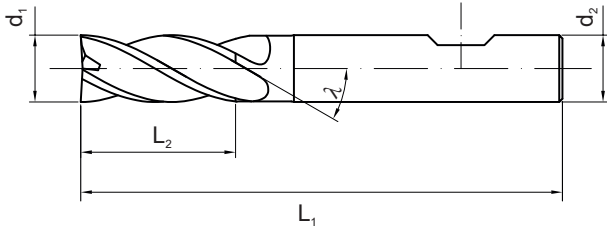

2-ostrowe do rowków na wpusty	2-ostrowe do rowków na wpusty
HSS Co8	HSSE PM AITiN

d ₁ e8	d ₂ h6	L ₁	L ₂	Z	INDEX M2-220418		INDEX M4-220417	
2	6	48	4	2	0020	•		
2,5	6	49	5	2	0025	o		
3	6	49	5	2	0030	•	0030N	•
3,5	6	50	6	2	0035	o		
4	6	51	7	2	0040	•	0040N	•
4,5	6	51	7	2	0045	o		
5	6	52	8	2	0050	•	0050N	•
5,5	6	52	8	2	0055	o		
6	6	52	8	2	0060	•	0060N	•
6,5	10	60	10	2	0065	o		
7	10	60	10	2	0070	o	0070N	o
7,5	10	60	10	2	0075	o		
8	10	61	11	2	0080	•	0080N	•
8,5	10	61	11	2	0085	o		
9	10	61	11	2	0090	o	0090N	o
9,5	10	61	11	2	0095	o	0095N	
10	10	63	13	2	0100	•	0100N	•
10,5	12	70	13	2	0105	o		
11	12	70	13	2	0110	o		
11,5	12	70	13	2	0115	o		
12	12	73	16	2	0120	•	0120N	•
13	12	73	16	2	0130	o		
14	12	73	16	2	0140	•	0140N	o
15	12	73	16	2	0150	o		
16	16	79	19	2	0160	•	0160N	•
17	16	79	19	2	0170	o		
18	16	79	19	2	0180	•	0180N	o
19	16	79	19	2	0190	o		
20	20	88	22	2	0200	•	0200N	•
22	20	88	22	2	0220	o		
24	25	102	26	2	0240	o		
25	25	102	26	2	0250	•	0250N	•
25	20*	96	26	2	2520	o		
26	25	102	26	2	0260	o		•
28	25	102	26	2	0280	o	0280N	o
28	20*	96	26	2	2820	o		
30	25	102	26	2	0300	o		
32	32	112	32	2	0320	o		
36	32	112	32	2	0360	o		
40	32*	118	38	2	0400	o		

* ≠DIN 327

DIN
327

DIN
1835-B

$\lambda=25^\circ$

$\gamma=12^\circ$

Z=2

HSS
Co8

UNI

DIN-327

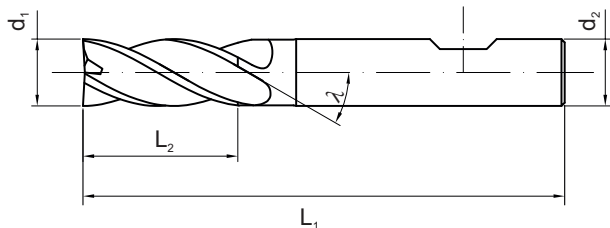
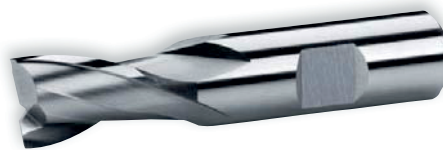

długie



Typ
N

d_1 e8	d_2 h6	L_1	L_2	Z	INDEX M2-221418	
4	6	63	11	2	0040	o
5	6	68	13	2	0050	o
6	6	68	13	2	0060	o
7	10	80	16	2	0070	o
8	10	88	19	2	0080	o
9	10	88	19	2	0090	o
10	10	95	22	2	0100	o
11	12	102	22	2	0110	o
12	12	110	26	2	0120	o
13	12	110	26	2	0130	o
14	12	110	26	2	0140	o
15	12	110	26	2	0150	o
16	16	123	32	2	0160	o
18	16	123	32	2	0180	o
20	20	141	38	2	0200	o
22	20	141	38	2	0220	o
24	25	166	45	2	0240	o
25	25	166	45	2	0250	o
26	25	166	45	2	0260	o
28	25	166	45	2	0280	o
30	25	166	45	2	0300	o
32	32	166	53	2	0320	o

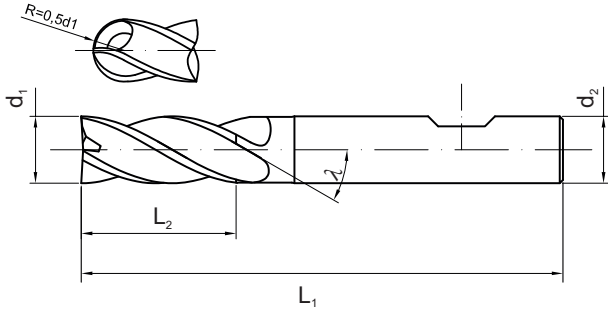

DIN-1889



2-ostrzowe
kuliste

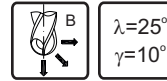

d ₁ k10	d ₂ h6	L ₁	L ₂	INDEX M2-510418	
4	6	51	7	0040	o
5	6	52	8	0050	•
6	6	52	8	0060	•
7	10	60	10	0070	o
8	10	61	11	0080	•
9	10	61	11	0090	o
10	10	63	13	0100	•
11	12	70	13	0110	o
12	12	73	16	0120	•
13	12	73	16	0130	o
14	12	73	16	0140	o
15	12	73	16	0150	o
16	16	79	19	0160	•
18	16	79	19	0180	o
20	20	88	22	0200	•
22	20	88	22	0220	o
24	25	102	26	0240	o
25	25	102	26	0260	o
28	25	102	26	0280	o
30	25	102	26	0300	o
32	32	112	32	0320	o

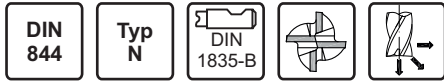

UNI

DIN-844

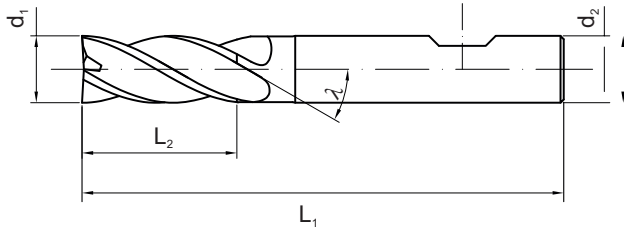

krótkie		krótkie	
HSS Co8	$\lambda=30^\circ$ $\gamma=8^\circ$	HSSE PM	$\lambda=30^\circ$ $\gamma=12^\circ$ AITiN

d_1 k10	d_2 h6	L_1	L_2	Z	INDEX M2-120518		INDEX M4-120517	
3	6	52	8	4	0030	•		
4	6	55	11	4	0040	•	0040N	•
5	6	57	13	4	0050	•	0050N	•
6	6	57	13	4	0060	•	0060N	•
7	10	66	16	4	0070	•		
8	10	69	19	4	0080	•	0080N	•
9	10	69	19	4	0090	o		
10	10	72	22	4	0100	•	0100N	•
11	12	79	22	4	0110	o		
12	12	83	26	4	0120	•	0120N	•
13	12	83	26	4	0130	o		
14	12	83	26	4	0140	o	0140N	o
15	12	83	26	4	0150	o		
16	16	92	32	4	0160	•	0160N	•
18	16	92	32	4	0180	o	0180N	o
20	20	104	38	4	0200	•	0200N	•
22	20	104	38	5	0220	o		
24	25	121	45	5	0240	o		
25	25	121	45	5	0250	o		
26	25	121	45	5	0260	o		
28	25	121	45	5	0280	o		
30	25	121	45	5	0300	o		
32	32	133	53	6	0320	o		

DIN
844

DIN
1835-B

$\lambda=30^\circ$
 $\gamma=8^\circ$

HSS
Co8

UNI

DIN-844

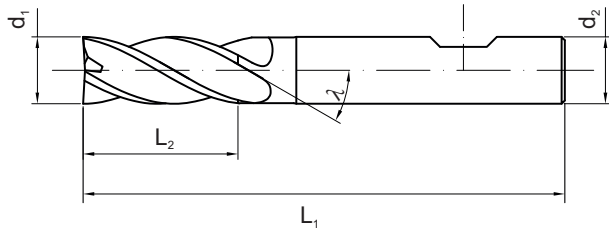

długie

 Typ
N

d_1 k10	d_2 h6	L_1	L_2	Z	INDEX M2-121518	
6	6	68	24	4	0060	•
7	10	80	30	4	0070	○
8	10	88	38	4	0080	•
9	10	88	38	4	0090	○
10	10	95	45	4	0100	•
12	12	110	53	4	0120	•
14	12	110	53	4	0140	○
16	16	123	63	4	0160	•
18	16	123	63	4	0180	○
20	20	141	75	4	0200	•
22	20	141	75	5	0220	○
24	25	166	90	5	0240	○
25	25	166	90	5	0250	○
26	25	166	90	5	0260	○
28	25	166	90	5	0280	○
30	25	166	90	5	0300	○
32	32	186	106	6	0320	○

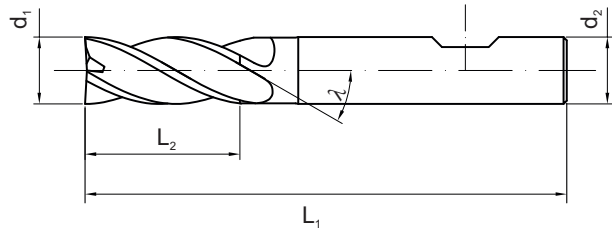

DIN-844



krótkie



d ₁ k12	d ₂ h6	L ₁	L ₂	Z	INDEX M2-124518	
6	6	57	13	4	0060	•
7	10	66	16	4	0070	○
8	10	69	19	4	0080	•
9	10	69	19	4	0090	○
10	10	72	22	4	0100	•
11	12	79	22	4	0110	○
12	12	83	26	4	0120	•
13	12	83	26	4	0130	○
14	12	83	26	4	0140	○
15	12	83	26	4	0150	○
16	16	92	32	4	0160	•
17	16	92	32	4	0170	○
18	16	92	32	4	0180	○
20	20	104	38	4	0200	•
22	20	104	38	5	0220	○
24	25	121	45	5	0240	○
25	25	121	45	5	0250	○
26	25	121	45	5	0260	○
28	25	121	45	5	0280	○
30	25	121	45	5	0300	○
32	32	133	53	6	0320	○

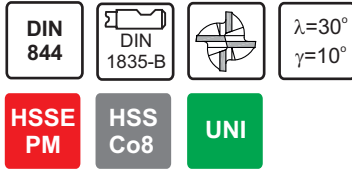

DIN-844

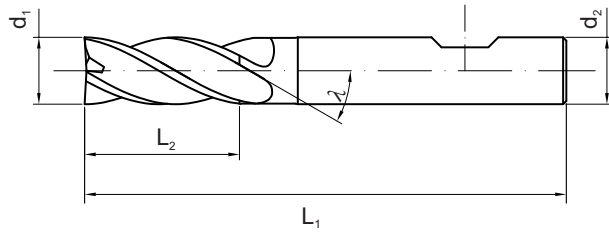

krótkie

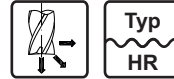

d_1 k12	d_2 h6	L_1	L_2	Z	INDEX M4-128517	
6	6	57	13	4	0060	•
7	10	66	16	4	0070	○
8	10	69	19	4	0080	•
9	10	69	19	4	0090	○
10	10	72	22	4	0100	•
11	12	79	22	4	0110	○
12	12	83	26	4	0120	•
13	12	83	26	4	0130	○
14	12	83	26	4	0140	○
15	12	83	26	4	0150	○
16	16	92	32	4	0160	•
17	16	92	32	4	0170	○
18	16	92	32	4	0180	○
20	20	104	38	4	0200	○
22	20	104	38	5	0220	○
24	25	121	45	5	0240	○
25	25	121	45	5	0250	○
26	25	121	45	5	0260	○
28	25	121	45	5	0280	○
30	25	121	45	5	0300	○
32	32	133	53	6	0320	○

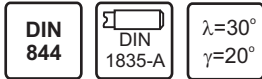

DIN-844

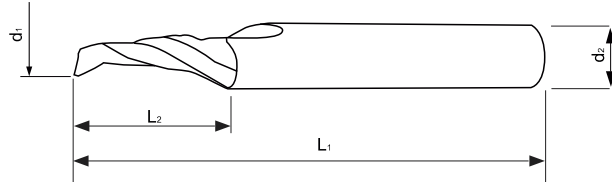

krótkie

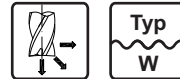

d_1 js 16	d_2 h6	L_1	L_2	Z	INDEX M2-100405	
3	8	60	12	1	0030	o
4	8	60	12	1	0040	o
5	8	60	13	1	0050	o
6	8	60	16	1	0060	o
7	8	60	16	1	0070	o
8	8	80	16	1	0080	o
10	10	80	15	1	0100	o



DIN-844

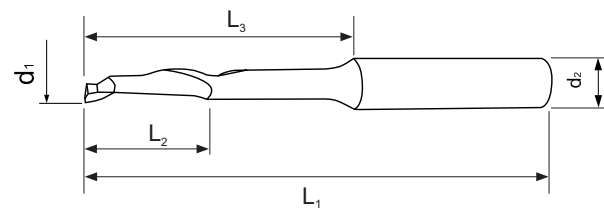

długie



d_1 js 16	d_2 h6	L_1	L_2	L_3	Z	INDEX M2-101405	
4	8	80	45	45	1	0040	o
5	8	80	45	45	1	0050	o
6	8	90	45	45	1	0060	o
8	8	100	70	70	1	0080	o

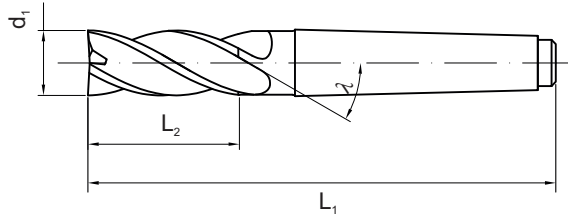
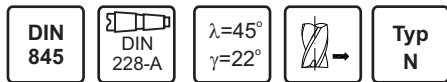

DIN-845



krótkie, z chwytem Morse'a

d ₁ k10	L ₁	L ₂	MK	Z	INDEX M2-420245	
10	92	22	1	4	0100	•
12	111	26	2	4	0120	•
14	111	26	2	4	0140	○
16	117	32	2	4	0160	•
18	117	32	2	4	0180	○
20	123	38	2	4	0200	•
22	123	38	2	5	0220	○
25	147	45	3	5	0250	•
28	147	45	3	5	0280	○
30	147	45	3	6	0300	•
32	178	53	4	6	0320	○
36	178	53	4	6	0360	○
40	188	63	4	6	0400	○
45	188	63	4	6	0450	○
50	233	75	5	6	0500	○
56	233	75	5	8	0560	○
63	248	90	5	8	0630	○

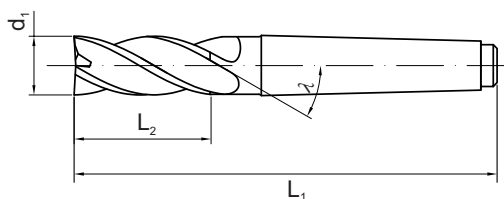
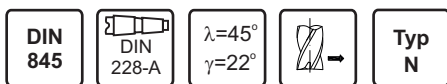

DIN-845



długie, z chwytem Morse'a

d ₁ k10	L ₁	L ₂	MK	Z	INDEX M2-421245	
10	115	45	1	4	0100	•
12	138	53	2	4	0120	•
14	138	53	2	4	0140	○
16	148	63	2	4	0160	•
18	148	63	2	4	0180	○
20	160	75	2	4	0200	•
22	160	75	2	5	0220	○
24	192	90	3	5	0240	○
25	184	80	3	5	0250	•
25	192	90	3	5	0250A	○
26	192	90	3	5	0260	○
28	192	90	3	5	0280	○
30	192	90	3	5	0300	•
32	229	100	4	6	0320	○
32	231	106	4	6	0320A	○
36	231	106	4	6	0360	○
40	250	125	4	6	0400	○
45	250	125	4	6	0450	○
50	268	110	5	6	0500	○
50	308	150	5	6	0500A	○
56	308	150	5	8	0560	○
63	338	180	5	8	0630	○

LEGENDA

Typy frezów

Typ N	Do obróbki wykańczającej standardowych materiałów o wytrzymałości Rm<900MPa
Typ NR	Do obróbki zgrubnej standardowych materiałów o wytrzymałości Rm<700MPa
Typ HR P	Do obróbki zgrubnej materiałów trudnoobrabialnych o wytrzymałości Rm<1200MPa
Typ W	Do obróbki metali miękkich takich jak aluminium i metale nieżelazne.

Rodzaje chwytów frezów węglkowych

DIN 6535-HA	Chwył cylindryczny prosty wg normy DIN 6535-HA
DIN 6535-HB	Chwył cylindryczny ze spłaszczeniem WELDON wg normy DIN 6535-HB

Rodzaje powłok

TiAlN	Powłoka PVD azotek tytanowo-aluminiowy
AlTiN	Powłoka PVD azotek aluminiowo-tytanowy

Normy wykonania frezów

DIN 844	DIN 327	DIN 1889	DIN 845
----------------	----------------	-----------------	----------------

Rodzaje chwytów frezów stalowych

DIN 1835-A	Chwył cylindryczny prosty wg normy DIN 1835-A
DIN 1835-B	Chwył cylindryczny ze spłaszczeniem WELDON wg normy DIN 1835-B
DIN 228-A	Chwył stożkowy MORSE'A z gwintem wg normy DIN 228-A

Geometria części roboczej

$\lambda=30^\circ$ $\gamma=10^\circ$	Geometria ostrza
	Kierunki obróbki
	Frez z promieniem naroża
	Frez z fazą naroża
	Frez kulisty

Czoła frezów

	frez 2-ostrowy z centralnym ostrzem
	frez 3-ostrowy z centralnym ostrzem
	frez 4-ostrowy lub wieloostrowy z centralnym ostrzem
	frez 4-ostrowy lub wieloostrowy z pogłębieniem na czole

Materiał ostrza

VHM	Węgiel spiekany drobnziarnisty
HSSE PM	Stal szybkotnąca proszkowa
HSS Co8	Stal szybkotnąca z 8% zawartością kobaltu
HSS Co5	Stal szybkotnąca z 5% zawartością kobaltu

Grupy zastosowań

UNI	Zastosowanie uniwersalne do szerokiej gamy typowych materiałów
------------	--

Wysięg narzędzia - definiowany jest jako odległość końca narzędzia do oprawki.

Siły skrawania odpychają narzędzie powodując ugięcie. Siły skrawania powstają przy udziale takich składowych jak: obroty wrzeciona, osiowa i promieniowa głębokość skrawania, posuwy i rodzaj materiału obrabianego.

Stosując minimalny wysięg możemy uzyskać:

- Redukcję drgań
- Zwiększyć żywotności narzędzia
- Poprawić jakość powierzchni
- Zwiększyć posuwy i prędkości
- Zwiększyć wydajność skrawania

Zasada:

Max. wysięg 8:1 długości ostrza.

Max. wysięg 12:1 długości całkowitej

Rodzaje operacji frezowania:

- frezowanie kanałków, frezowanie wcinaniem – praca pełną średnicą narzędzia 1xD
- frezowanie zgrubne – praca w zakresie 0,5 do 1xD średnicy narzędzia
- frezowanie wykańczające profilowe - praca w zakresie 0,1 do 0,2xD
- kopiowanie frezem kulistym z małymi naddatkami – prace w zakresie 0,02 do 0,05xD



TABELA OBRABIANYCH MATERIAŁÓW

USA	Niemcy	DIN	Francja	GB	Chiny	Japonia
STAL						
1018 / 1020	1,1151	Ck22	XC15	050A20	20	S20C
1045	1.0503, 1,1201	Ck45, CM45	AF65C45, C45	080M46, 060A47	45	S45C
4140	1,7225	42CrMo4	42CD4, 42CrMO4	708M40 EN 19A	42CrMo	SCM440
4340	1.6562, 1,6582	40NiCrMo73, 34NiCrMo8	35ncd6, 34CrNiMo6		40CrNiMOA	SNCM8
ZELIWO						
Gray	0.6010, 0.6200, 0.6025, 0.6035	GG10, GG20, GG25, GG35	Ft10D, FGL100, Ft25D, FGL250, Ft35D, FGL350	Grade 220, Grade 260, Grade 350	HT150, HT200, HT250, HT350	FC100, FC200, FC250, FC350
Ductile	0.705, 0.707, 0.8035, 0.8170	GGG50, GGG70, GTW35-04, GTS70-02	FFG5500-7, FGS 700-2, MB 35-7, MP 70-02	500/7, 700/2, W 340/3, P 690/2	QT500-7, HT700-2	FCD500, FCD700
TWORZYWA SZTUCZNE						
Poliwęglany, Duroplasty (Bakelit, Resopal, Pertinax, Moltoperm), Termoplasty (Plexiglass, Hostalen, Novodur, Makralon)						
METALE NIEŻELAZNE						
High Silicon Bronze, Beryllium Copper, Brass	2.0070, 2.1020, 2.1096, 2.0380, 2.0410, 2.1090, 2.1170, 2.0916, 2.1050	SE-Cu, CUSn6, G-CuSn5ZNPb, RGS, CuZn40, 44Pb2, G-CuSn72nPb, G-CuSn10Zn, CuAl6	CuPb55n5Zn5, CuZn40, 44Pb2, CuSn7Pb6Zn4	LG-2, CZ109, CZ130, LB-5, G-1	Hxx, Qxx, Bxx, Zxx	C3771, C3602, C3603, C3604, C5210, BC6, BC6C
STOPY MAGNEZU						
Magnesium		MgMn2, G-MgAl8Zn-1, G-MgAl6Zn3			MBxx, ZMxx	
ALUMINIUM ODLEWNICZE I STOPY ALUMINIUM						
2024, 6061, 7075, A380, A390	3.1355, 3.3206, 3.4365, 3.2161	AlCuMg2, AlMgSi0.5, AlZnMgSu1.5, G-AlSi8Cu3, AlSi17Cu4	A-U4G1, A-Z5GU, A55U	2L98, H9, 2L95, LM24	LY9, LD2, LD3, LC4	A2024S, A6061S, A7075S, ADC10
TYTAN I JEGO STOPY						
6Al4V, Pure, 6- 2222, 10V2Fe3Al, 6Al2Sn4Zr6Mo	3.7024/25, 3.7124, 3.7154, 3.7164/65, 3.7184	Ti99.8, TiCu2, TiAl6Zr5Mo0.5SiO, 2, TiAl6V4, TiAl4Mo4Sn2Si	T-35, T-U2, T- A6ZD, T-A6V, T-A4DE	TA.1, TA.21-24/52- 55/58, TA 43/44, TA 10- 13/28/25	TA-x, TB-x, TC-x	
STOPY SPECJALNE						
Inconel, Nimonic, Monel, Hastelloy						
STALE KWASOODPORNE I NIERDZEWNE						
Sulphured 416, 430	1.4005, 1.4104	X12CrS13, X12CrMoS17	212CF13, Z12CrS13, Z10CF17	416S21	1Cr17	SUS430
Austenitic 304, 321	1.4301, 1.4541	X5CrNi1810, X6CrNiCuNb1714	26CN18.09, Z6CNT18.10	304S15EN 58E, 321S12/531 EN 588	0Cr18Ni9, 0Cr18Ni10Ti	SUS304, SUS321
Martensitic 431	1.4057, 1.4122	X20CrNi 172, X39CrMo 171	Z15CN16.02	431S29 EN 57	1Cr17Ni2	SUS431
316L, 304L	1.4435 , 1.4306	X2CrNiMo18143, G-X2CrNi189/1911	22CND17.13, Z2CN18.10, Z3CN19.10m	316S11/S12, 304S12/511/C2	00Cr17Ni14M02, 00Cr18Ni10	SUS304L, SCS19, SUS316L, SUN310
STALE NARZĘDZIOWE						
D-2, A-2, P-20	1.2379, 1.2363, 1.2311	X15CrVMo121, G-X100CrMoV51, 40CrMnMo7	Z160CDV12, Z100CDV5	BD2, BA2	Cr12M01V, Dr5M01V	SKD12, SKD1
H13, W1	1.2344, 1.175	X40CrMoV51, C75W	240CDV5	BH13, BW1A	4Cr5MoSiV1	
GRAFIT I KOMPOZYTY						
Grafit, włókna węglowe, ceramika						

Tabela prędkości skrawania v_c dla frezów HSSE i HSSE-PM

	Materiał obrabiany	Rm [MPa]	Twardość HB	Twardość HRC	Vc m/min		
					HSSCo5	HSSCo8	HSSE-PM AITIN
1 Stal							
1.1	Stal głęboko tłoczna, stal magnetyczna, miękka	<400	<120	-	37	45	76
1.2	Stal automatowa, stal konstrukcyjna, stal do nawęglania	300 ÷ 500	100 ÷ 150	-	37	45	76
1.3	Stal konstrukcyjna węglowa i niskostopowa, staliwo	400 ÷ 800	120 ÷ 240	-	32	39	66
1.4	Stal do ulepszenia, stal stopowa, stal narzędziowa	800 ÷ 1000	240 ÷ 300	22 ÷ 32	18	24	41
1.5	Stal ulepszana do 38HRC,	1000 ÷ 1200	-	32 ÷ 38	18	24	41
1.6	Stal ulepszana do 44HRC, stal szybko tnąca	1200 ÷ 1400	-	38 ÷ 44	16	20	34
1.7	Stal hartowana do 60HRC	-	-	50 ÷ 60	-	-	-
2 Stal nierdzewna							
2.1	Stal ferrytyczna, martenzytyczna	400 ÷ 1000	120 ÷ 300	-	10	15	25
2.2	Stal austenityczna	500 ÷ 850	150 ÷ 250	-	8	12	21
2.3	Stal żaroodporna	500 ÷ 1100	150 ÷ 325	-	8	12	21
3 Żeliwo							
3.1	Żeliwo szare	400 ÷ 700	100 ÷ 210	-	30	35	59
3.2	Żeliwo szare	700 ÷ 1000	210 ÷ 300	15 ÷ 32	30	35	59
3.3	Żeliwo sferoidalne, ciągliwe	400 ÷ 700	100 ÷ 210	-	22	25	44
3.4	Żeliwo sferoidalne, ciągliwe	700 ÷ 1000	210 ÷ 300	15 ÷ 32	22	25	44
4 Tytan							
4.1	Tytan niestopowy	500 ÷ 700	150 ÷ 210	-	9	12	20
4.2	Stopy tytanu	700 ÷ 1250	210 ÷ 370	15 ÷ 40	9	12	20
5 Nikiel							
5.1	Nikiel niestopowy	<500	<150	-	-	-	-
5.2	Stopy niklu	500 ÷ 1250	150 ÷ 370	-	-	-	-
6 Miedź							
6.1	Miedź niestopowa i niskostopowa	<350	<105	-	60 ÷ 100	80 ÷ 120	120 ÷ 200
6.2	Mosiądz, brąz krótkowiórowy	<700	<210	-	60 ÷ 100	80 ÷ 120	120 ÷ 200
6.3	Mosiądz długowiórowy	<700	<210	-	60 ÷ 100	80 ÷ 120	120 ÷ 200
6.4	Brąz stopowy (aluminiumowy)	<1200	<355	<38	-	-	-
7 Aluminium							
7.1	Aluminium niestopowe	<350	<105	-	160 ÷ 250	160 ÷ 300	240 ÷ 450
7.2	Stopy aluminium Si < 5%	<700	<210	-	160 ÷ 250	160 ÷ 300	240 ÷ 450
7.3	Stopy aluminium 5% < Si < 10%	<400	<120	-	160 ÷ 250	160 ÷ 300	240 ÷ 450
7.4	Stopy aluminium Si > 10%	<400	<120	-	-	-	-
8 Tworzywa sztuczne							
8.1	Termoplasty	-	-	-	-	-	-
8.2	Duroplasty, tworzywa zbrojone	-	-	-	-	-	-

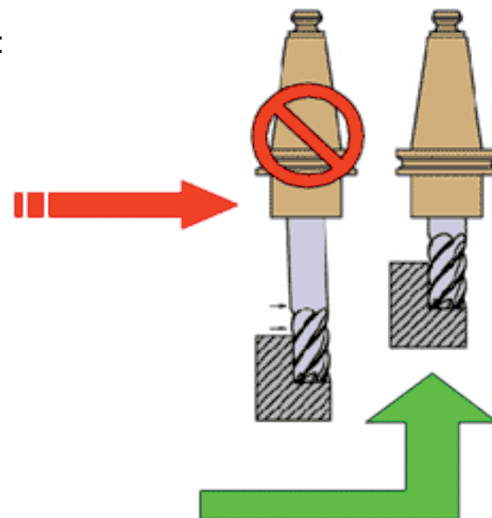
UWAGI:

Podane w tabeli prędkości skrawania mają charakter orientacyjny. Dla narzędzi pokrywanych PVD prędkości można zwiększyć:
 - dla TiN o 30%,
 - dla TiCN o 40%,
 - dla TiAlN, AlTiN o 50%.

Tabela posuwów na ząb f_z dla frezów HSSE i HSSE-PM

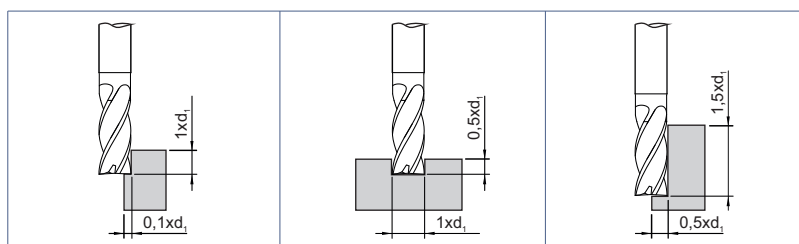

Średnica d_1	Niepokryte		Pokryte		Niepokryte		Pokryte	
	1	2	3	4	5	6	7	8
2	0,003	0,003	0,006	0,007				
3	0,008	0,009	0,013	0,014				
4	0,015	0,017	0,022	0,024				
5	0,028	0,031	0,036	0,040				
6	0,040	0,044	0,051	0,056	0,020	0,022		
8	0,051	0,056	0,065	0,072	0,035	0,039		
10	0,063	0,069	0,080	0,088	0,060	0,066		
12	0,080	0,088	0,102	0,112	0,080	0,088		
14	0,100	0,110	0,130	0,140	0,095	0,105		
16	0,120	0,130	0,130	0,140	0,110	0,121		
18	0,006	0,007	0,009	0,010	0,025	0,028		
20	0,011	0,012	0,016	0,018	0,040	0,044		
22	0,021	0,023	0,029	0,032	0,070	0,077		
25	0,034	0,037	0,044	0,048	0,090	0,100		
28	0,044	0,048	0,058	0,064	0,100	0,110		
32	0,057	0,063	0,073	0,080	0,120	0,132		
36	0,071	0,078	0,091	0,100				
40	0,091	0,100	0,116	0,128				
45	0,110	0,120	0,130	0,140				
50	0,130	0,140	0,130	0,140				
63	0,140	0,150						

$$n = \frac{1000 \cdot v_c}{\pi \cdot D} \quad [\text{obr/min}]$$

$$v_f = n \cdot z \cdot f_z \quad [\text{mm/min}]$$

*Wszelkie prawa zastrzeżone. Przedruk i kopiowanie w części lub w całości dozwolone wyłącznie za zgodą FANAR S.A.
Błędy wynikłe z niewłaściwej interpretacji oraz błędy drukarskie nie upoważniają do jakichkolwiek roszczeń.
Zastrzegamy sobie prawo do wprowadzenia w międzyczasie zmian technicznych.*

Wydanie 2014

Opracowanie:
Krystian Stryjewski

Projekt okładki:
„Active Project” - Siedlce

Druk:
Ciechanów

Ciechanów, Wrzesień 2014 r.

Frezy trzpieniowe *Opti Line*

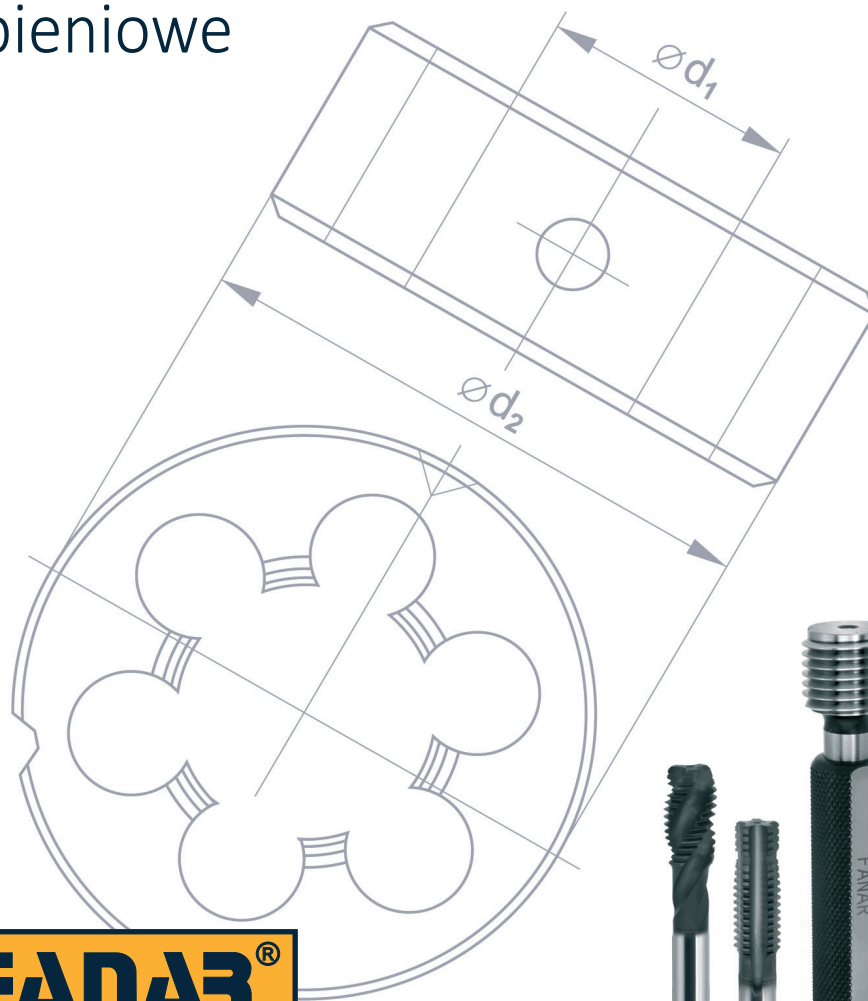

Fabryka Narzędzi FANAR Spółka Akcyjna

ul. Płocka 11, 06-400 Ciechanów
tel.: (48 23) 672 44 41, fax: (48 23) 672 48 41
e-mail: info@fanar.pl, www.fanar.pl

Biuro Obsługi Klienta

tel. (48 23) 672 44 44
e-mail: bok@fanar.pl

Export Department

tel. (48 23) 674 30 03
tel. (48 23) 674 30 35 
e-mail: export@fanar.pl

katalog
2014